

Part No. P0604218 02

# **CallPilot 100/150**

## **Installation and Maintenance Guide**

**NORTEL**  
**NETWORKS™**

## Copyright © 2003 Nortel Networks

All rights reserved. May 12, 2003.

The information in this document is subject to change without notice. The statements, configurations, technical data, and recommendations in this document are believed to be accurate and reliable, but are presented without express or implied warranty. Users must take full responsibility for their applications of any products specified in this document. The information in this document is proprietary to Nortel Networks NA Inc.

## Trademarks

NORTEL NETWORKS is a trademark of Nortel Networks.

All other trademarks and registered trademarks are the property of their respective owners.

## Statement of conditions

In the interest of improving internal design, operational function, and/or reliability, Nortel Networks NA Inc. reserves the right to make changes to the products described in this document without notice.

Nortel Networks NA Inc. does not assume any liability that may occur due to the use or application of the product(s) or circuit layout(s) described herein.

## Regulatory Requirements

CallPilot 100/150 meets CSPR22 Class A regulatory requirements.

### FCC Regulations

This equipment complies with Federal Communications Commission Rules and Regulations Part 68 when connected to a Norstar switch. This equipment does not connect directly to the public switched telephone network.

### DOC Regulations

This equipment complies with the Canadian Department of Commerce CS-03 Rules and Regulations for connection to Norstar switches.

### Radio Frequency Interference

This equipment generates, uses and can radiate radio frequency energy and if not installed and used in accordance with the instruction manual may cause interference to radio communications. It has been tested and found to comply with the limits for a Class A computing device pursuant to Part 15 of the FCC Rules and CSDA specification C108.8, which are designed to provide reasonable protection against such interference when operated in a commercial environment. Operation of this equipment in a residential area is likely to cause interference, in which case users will be required, at their own expense, to take whatever measures are necessary to correct the interference.

This apparatus does not exceed the Class A limits for radio noise emissions from digital apparatus set out in the Radio Interference Regulations by the Canadian Department of Commerce.

CallPilot 100/150 contains fragile electronic parts. Do not drop or bump it.

**警告使用者：**  
這是甲類的資訊產品，在居住的環境中使用時，  
可能會造成射頻干擾，在這種情況下，使用者會  
被要求採取某些適當的對策。

---

# Contents

---

<b>Preface</b> .....	<b>11</b>
Before you begin .....	11
Text conventions .....	11
About the buttons on your telephone .....	12
Related publications .....	12
How to Get Help .....	13
USA and Canada .....	13
Authorized Distributors - ITAS Technical Support .....	13
Presales Support (CSAN) .....	13
EMEA (Europe, Middle East, Africa) .....	13
Technical Support - CTAS .....	13
CALA (Caribbean & Latin America) .....	14
Technical Support - CTAS .....	14
APAC (Asia Pacific) .....	14
Technical Support - CTAS .....	14
<b>Chapter 1</b>	
<b>How to use this guide</b> .....	<b>15</b>
How to use this guide .....	15
How the instructions are presented .....	16
Warning and caution symbols .....	16
<b>Chapter 2</b>	
<b>System overview</b> .....	<b>17</b>
About CallPilot 100/150 .....	17
CallPilot 100/150 offers .....	17
Features of CallPilot .....	17
Compatibility .....	18
Hardware overview .....	18
Data connectors .....	18
PCMCIA slots .....	19
Dimensions .....	19
Voice message storage .....	20
Power .....	20
<b>Chapter 3</b>	
<b>Preparing to install the CallPilot 100/150</b> .....	<b>21</b>
Environment .....	21
Electrical service .....	21
Opening the kit .....	21

---

Managing the CallPilot system .....	22
Running without a LAN .....	22
Using a LAN .....	22
DNS server .....	22
<b>Chapter 4</b>	
<b>Installing CallPilot 100/150 .....</b>	<b>23</b>
Wall mounting the CallPilot 100/150 .....	23
Connecting the CallPilot 100/150 .....	24
CallPilot 100/150 LEDs .....	26
<b>Chapter 5</b>	
<b>Initializing the CallPilot 100/150 .....</b>	<b>29</b>
About CallPilot Manager .....	29
Initializing CallPilot 100/150 using CallPilot Manager .....	30
Computer requirements for CallPilot Manager .....	30
Computer requirements .....	30
Browser requirements .....	30
Connecting to the CallPilot 100/150 .....	31
Changing the IP address using a serial cable .....	31
Changing the IP address using an Ethernet crossover cable .....	34
Running the Quick Install Wizard .....	35
Initializing CallPilot 100/150 using a telephone .....	38
Determining CallPilot 100/150 Feature Codes .....	38
Configuring the CallPilot 100/150 initial parameters .....	39
<b>Chapter 6</b>	
<b>Language Configuration Utility .....</b>	<b>43</b>
Changing the languages available .....	43
<b>Chapter 7</b>	
<b>Password administration .....</b>	<b>45</b>
Resetting passwords .....	45
Resetting the system administrator password .....	45
Resetting the operator password .....	46
Resetting the password using CallPilot Manager .....	46
Resetting the password using a telephone .....	46
Resetting the Mailbox passwords .....	47
Resetting the password using CallPilot Manager .....	47
Resetting the password using a telephone .....	47
Resetting the Call Center Administrator password .....	48
Resetting the Modem access password .....	48
Resetting the Modem access password using a telephone .....	48

---

<b>Chapter 8</b>	
<b>Backing up and restoring CallPilot</b>	<b>51</b>
Installing the CallPilot Backup and Restore Utility	51
Backing up the CallPilot information	51
Restoring the CallPilot information	53
Retrieving the CallPilot log files	55
<b>Chapter 9</b>	
<b>Upgrading CallPilot 100/150</b>	<b>57</b>
Upgrading the CallPilot software version	57
Upgrading the message storage	58
<b>Chapter 10</b>	
<b>Troubleshooting</b>	<b>61</b>
Introduction	61
Diagnosing problems	61
The RS-232 terminal cannot communicate with CallPilot 100/150	61
CallPilot 100/150 does not function at all	62
The Power-on Diagnostics fail	63
Cannot access CallPilot Manager	63
CallPilot 100/150 fails during a start up	63
All of the mailboxes disappear after a software upgrade	63
CallPilot 100/150 Feature Codes are inactive	64
To remove Feature Codes	64
CallPilot 100/150 does not reboot following **STARTUP	65
Inactive feature	65
Time on the CallPilot 100/150 does not match the time on the telephone system	66
LED error messages	66
LED 1 is blinking quickly	66
LED 1 and LED 2 are blinking quickly	66
LEDs 1 to 4 turn on at power up but do not briefly turn off during start up	66
One or more of LEDs 1 to 4 do not turn on after CallPilot 100/150 has finished starting up	66
LED 6 does not turn on after CallPilot 100/150 has finished starting up	66
<b>Appendix A</b>	
<b>Modem Access</b>	<b>67</b>
Configuring your computer to access the CallPilot modem	67
Connecting a telephone to your computer modem	67
Creating a Dial-Up Networking connection	68
Creating a Dial-Up Networking connection on Windows 95 or Windows 98	68
Configuring the Dial-Up Networking TCP/IP parameters on Windows 95 or Windows 98	68

---

---

Creating a Dial-Up Networking connection on Windows NT 4.0 .....	69
Configuring the Dial-Up Networking TCP/IP parameters on Windows NT 4.0 .....	70
Creating a Dial-Up Networking connection on Windows 2000 or Windows XP .....	71
Configuring the Dial-Up Networking TCP/IP parameters on Windows 2000 or Windows XP .....	71
Installing the Nortel Networks Modem Configuration Utility .....	72
Enabling the CallPilot modem .....	73
Enabling Modem access using CallPilot Manager .....	73
Enabling Modem access using a telephone .....	73
Changing the modem access password using a telephone .....	74
Disabling the Modem access password using a telephone .....	74
Connecting to the CallPilot system .....	75
Configuring your modem to access the CallPilot modem .....	75
Connecting to the CallPilot modem .....	75
Configuring your modem for normal modem connections .....	77
<b>Appendix B</b>	
<b>Norstar Directory Numbers</b> .....	<b>79</b>
Programming CallPilot 100/150 DNs to memory buttons .....	80
<b>Glossary</b> .....	<b>81</b>
<b>Index</b> .....	<b>87</b>

---

## Figures

---

Figure 1	Inside the CallPilot 100/150 .....	19
Figure 2	Mounting the CallPilot 100/150 .....	23
Figure 3	CallPilot 100/150 connections .....	25
Figure 4	Ethernet crossover cable .....	34





---

## Tables

---

Table 1	Telephone buttons .....	12
Table 2	CallPilot features .....	17
Table 3	Compatible Norstar KSU systems .....	18
Table 4	Port A and Port B Pinouts .....	24
Table 5	LEDs during startup .....	26
Table 6	LEDs during operation .....	27
Table 7	CallPilot 100/150 serial port pinout .....	31
Table 8	Quick Install Wizard parameters for a CallPilot 100/150 .....	35
Table 9	Assigned Feature Codes .....	38
Table 10	Maximum disk space required to backup CallPilot 100/150 .....	52
Table 11	Non-expanded Modular ICS DNs .....	79
Table 12	Modular ICS 2-port cartridge DNs .....	79
Table 13	Modular ICS 6-port cartridge DNs .....	80



---

## Preface

---

The CallPilot 100/150 is a voice messaging product suited for small to medium sized businesses. It combines the voicemail and call processing features of a large business system into a compact, easy to use system.

## Before you begin

This guide is intended for install technicians. This guide assumes that you have a working knowledge of the telephone system on which you are installing the CallPilot 100/150.

## Text conventions











This guide uses the following text conventions:







angle brackets (< >)	Indicate that you choose the text to enter based on the description inside the brackets. Do not type the brackets when entering the command. Example: If the command syntax is <code>ping &lt;ip_address&gt;</code> , you enter <code>ping 192.32.10.12</code>
<b>bold Courier text</b>	Indicates command names and options and text that you need to enter. Example: Use the <code>dinfo</code> command. Example: Enter <code>show ip {alerts routes}</code> .
<i>italic text</i>	Indicates book titles. Example: <i>CallPilot Manager Set Up and Operation Guide</i>
plain Courier text	Indicates command syntax and system output, for example, prompts and system messages. Example: Set Trap Monitor Filters
<b>B U T T O N S</b>	Indicates the buttons you press on a telephone. Example: <b>☎ 9 8 3</b>
<b>Display font</b>	Indicates text prompts that appear on the telephone display. Example: <b>GROUP lists? Y</b>
<u><b>Underlined display font</b></u>	Indicates a label that appears above the display button. You press the button below this label to perform the action. Example: Press <u><b>OK</b></u> .

## About the buttons on your telephone

This guide shows the Business Series Terminal buttons. Table 1 shows which buttons to use on the different types of Nortel Networks telephones.

**Table 1** Telephone buttons

Button Name	T7100, T7208, T7316, T7316E	M7100, M7208, M7310, M7324	M7100N, M7208N, M7310N, M7324N
Feature		Feature	
Hold		Hold 	
Volume Control			
Release		Rls	

You can enter ,  or  and the code to use a feature. For example: Press     to access your mailbox.

The T7100 works differently from other telephones on your system because it does not have line buttons. Where other telephones can require that you select a line button to answer a call, with the T7100 terminal you pick up the handset. Where other telephones require you to select a line button to take a call off hold, you press  on the T7100 terminal.

On T7100 terminals, you can answer a second call by pressing . Your active call is put on hold and you connect to the waiting call. You can have no more than two active calls at one time.

The T7100 terminal does not have a  button.

## Related publications

For more information about programming CallPilot 100/150, refer to the following publications:

- *CallPilot Manager Set Up and Operation Guide*  
Provides instructions for setting up the CallPilot 100/150 using CallPilot Manager.
- *CallPilot 100/150 Telephone Administration Guide*  
Provides instructions for setting up the CallPilot 100/150 using a Norstar telephone.
- *CallPilot Programming Record*  
Provides a record of the settings used for the CallPilot 100/150.
- *Nortel Networks Call Center Set Up and Operation Guide*  
Provides instructions for setting up the Call Center features on CallPilot 100/150.
- *Nortel Networks Call Center Reporting Set Up and Operation Guide*  
Provides instructions for setting up the Call Center Reporting feature on CallPilot 100/150.

## How to Get Help

### USA and Canada

#### Authorized Distributors - ITAS Technical Support

*Telephone:*

1-800-4NORTEL (1-800-466-7835)

If you already have a PIN Code, you can enter Express Routing Code (ERC) 196#.  
If you do not yet have a PIN Code, or for general questions and first line support, you can enter ERC 338#.

*Website:*

<http://www.nortelnetworks.com/itas/>

#### Presales Support (CSAN)

*Telephone:*

1-800-4NORTEL (1-800-466-7835)

Use Express Routing Code (ERC) 1063#

### EMEA (Europe, Middle East, Africa)

#### Technical Support - CTAS

*Telephone:*

00800 800 89009 or 33 4 9296 1341

*Fax:*

33 49296 1598

*email:*

[emeahelp@nortelnetworks.com](mailto:emeahelp@nortelnetworks.com)

## **CALA (Caribbean & Latin America)**

### **Technical Support - CTAS**

*Telephone:*

1-954-858-7777

*email:*

csrmgmt@nortelnetworks.com

## **APAC (Asia Pacific)**

### **Technical Support - CTAS**

*Telephone:*

+61 388664627

*Fax:*

+61 388664644

*email:*

asia\_support@nortelnetworks.com

---

# Chapter 1

## How to use this guide

---

This guide explains:

- what CallPilot 100/150 is
- how to install CallPilot 100/150
- how to initialize CallPilot 100/150
- how to troubleshoot CallPilot 100/150

## How to use this guide

[Chapter 1, “How to use this guide](#) explains the contents of this guide and the conventions it uses.

[Chapter 2, “System overview](#) provides a functional overview of the CallPilot 100/150.

[Chapter 3, “Preparing to install the CallPilot 100/150](#) describes what is required before you install the CallPilot 100/150.

[Chapter 4, “Installing CallPilot 100/150](#) describes how to install the CallPilot 100/150.

[Chapter 5, “Initializing the CallPilot 100/150](#) describes how to program the initial parameters for the CallPilot 100/150.

[Chapter 6, “Language Configuration Utility](#) describes how to change the languages available on the CallPilot 100/150.

[Chapter 7, “Password administration](#) describes how to reset the passwords on CallPilot 100/150.

[Chapter 8, “Backing up and restoring CallPilot](#) describes how to back up and restore CallPilot information.

[Chapter 9, “Upgrading CallPilot 100/150](#) describes how to upgrade CallPilot 100/150.

[Chapter 10, “Troubleshooting](#) describes problems, error messages and corrective actions.

[Appendix A, “Modem Access](#) describes how to use a modem to access CallPilot 100/150.

[Appendix B, “Norstar Directory Numbers](#) describes the port numbers and default Directory Numbers (DNs) on various Norstar systems.

## How the instructions are presented

The tasks in this book are presented as step-by-step instructions, in the order you must carry them out.

### Warning and caution symbols

Sometimes you will see symbols warning you to be careful. These symbols include:



**Note:** alerts you to steps that are complicated or critical.

---



**Caution:** alerts you to situations where you may damage the equipment.

---



**Warning:** alerts you to situations where there is the possibility of injuring yourself.

---

Before you begin any task, read all the steps, including **Notes**, **Cautions**, and **Warnings**.



---

## Chapter 2

### System overview

---

#### About CallPilot 100/150

The CallPilot 100/150 is a voice messaging product suited for small to medium sized businesses. It combines the voicemail and call processing features of a large business system into a compact, easy to use system.

#### CallPilot 100/150 offers

- connection to a compatible Norstar telephone system
- voicemail with a choice of a CallPilot or Norstar Voice Mail interface
- up to eight voice channels
- Call Center functionality

#### Features of CallPilot

**Table 2** CallPilot features

Feature	CallPilot 100	CallPilot 150
Number of voice channels	4	8
Storage (hours)	9	24
Additional storage	No	Yes (to 59 hours)
Maximum number of subscriber mailboxes	40	300
Basic voicemail	Included	Included
Outbound transfer	Included	Included
Call recording, call interrupt	Included	Included
Auto-Attendant and Custom Call Routing (CCR)	Included	Included
Networking (digital, AMIS)	Optional	Optional
Desktop (Unified) Messaging	Optional	Optional
Basic Call Center	Optional	Optional
Call Center Reporting	Optional	Optional
Maximum Skillsets	2	2
Maximum active agents	10	10

## Compatibility

The CallPilot 100/150 can connect to these Norstar telephone systems:

**Table 3** Compatible Norstar KSU systems

Norstar system	Compatible software version
Modular ICS	4.1 or higher
Compact ICS	4.1 or higher
Compact 3X8 ICS	DR 5.1



**Note:** The Compact 3X8 ICS works with the CallPilot 100 only.

The Park and Page and AMIS Networking features are not available when the CallPilot 100 is connected to a Compact 3X8 ICS.



**Note:** CallPilot 100/150 does not work with Centrex KSUs.



**Note:** To use the Call Center feature, your KSU must support Disconnect Supervision.

## Hardware overview

The CallPilot 100/150 is a compact device that you can mount on a desk or on the wall.

[Figure 1](#) points out the various parts of the CallPilot hardware.

### Data connectors

The CallPilot 100/150 has the following connections:

- one RJ-45 jack for a 10/100 Mbps Ethernet connection to a local network
- one RS-232 port for connecting a terminal which provides alternative access
- two RJ-11 jacks, labeled Port A and Port B, for connections to a Norstar KSU.

On the CallPilot 100, each RJ-11 jack can support one TCM connection. Each TCM connection can support two voice channels. This gives the CallPilot 100 a total of four voice channels.

On the CallPilot 150, each RJ-11 jack can support two TCM connections. Each TCM connection can support two voice channels. This gives the CallPilot 150 a total of eight voice channels.

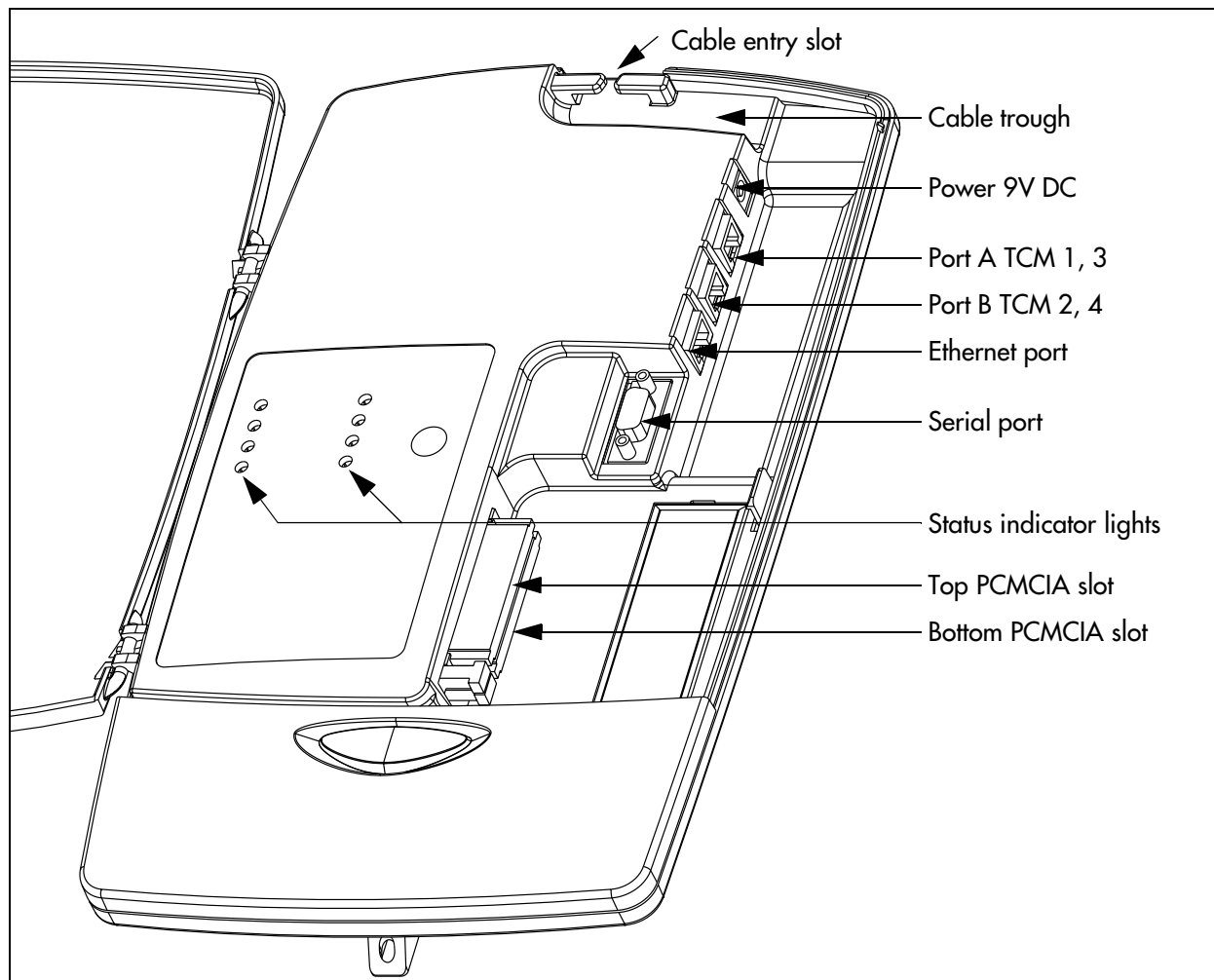
**Figure 1** Inside the CallPilot 100/150

## PCMCIA slots

The CallPilot 100/150 has two PCMCIA slots.

- The bottom slot is used for the feature cartridge. The feature cartridge is the device that stores the CallPilot software, greetings and voice messages.
- The top slot is used during software upgrades.

For the locations of the PCMCIA slots, refer to [Figure 1](#).

## Dimensions

The CallPilot 100/150 has the following dimensions:

- Height: 33 cm (13 inches)
- Width: 20 cm (8 inches)
- Depth: 4 cm (1.5 inches)

## **Voice message storage**

The voice message storage is the amount of memory that CallPilot 100/150/CallPilot 100 has to store greetings and voicemail messages.

The CallPilot 100 provides 9 hours of voice message storage.

The CallPilot 150 provides 24 hours of voice message storage. With the optional message storage upgrade, the CallPilot 150 provides 59 hours of voice message storage.

## **Power**

An external power supply provides 9V DC for the CallPilot 100/150. Use only the power supply that is provided with the CallPilot 100/150.

---

## Chapter 3

# Preparing to install the CallPilot 100/150

---

This chapter explains what you need before you install the CallPilot 100/150.

## Environment

Make sure the installation area is:

- clean, free of dust, dry and well ventilated
- between 0 and 50 degrees Celsius
- non-condensing relative humidity between 5 percent and 95 percent
- at least 4 m, or 13 ft., from any equipment that could produce electromagnetic, radio frequency and electrostatic interference
- a wall area about 1 m (3 ft.) square
- closer than 15 m, or 50 ft., of cable length from the Norstar KSU
- within 1.5 m, or about 5 ft., of a three-wire grounded electrical outlet
- a minimum of 16 cm, or 6 in., from a corner wall or other component
- a minimum of 46 cm, about 18 in., from the floor, to prevent water damage

## Electrical service

Make sure the power is:

- 115/230 VAC nominal; range 100 to 240 V
- 50/60 Hz nominal; range 47 to 63 Hz
- Third-wire ground
- Unswitched

## Opening the kit





Open the box and ensure that you have all the pieces, as described below:

- CallPilot 100/150
- Power supply and power cord
- Wall Mount Bracket
- Four-wire, two-meter line cord
- Documentation and Client Software CD

## Managing the CallPilot system

CallPilot 100/150 is managed using a telephone or CallPilot Manager, depending on whether the CallPilot 100/150 has a LAN connection.

### Running without a LAN

A LAN connection is optional for a basic CallPilot 100/150 system running on a Norstar system. When there is no LAN connection, you can administer the system through a telephone using the     menus.



**Note:** You require a LAN connection to print reports, administer the Networking feature, use the Backup and Restore Utility and use the Language Configuration Utility.

---

### Using a LAN

When there is a LAN connection, CallPilot 100/150 is managed through a web browser interface called CallPilot Manager.

To use CallPilot Manager, the CallPilot 100/150 system must have a fixed IP address.

All CallPilot 100/150 systems are shipped with the default IP address of 192.168.110.10. If this IP address conflicts with your network, you must change the address before connecting the CallPilot 100/150 to your network. You can change the IP address using a terminal connected to the CallPilot 100/150 serial port, or through a temporary Ethernet connection using an Ethernet crossover cable to a stand alone computer or laptop.

Detailed instructions for setting the IP address and accessing CallPilot Manager are provided in [“Initializing the CallPilot 100/150” on page 29](#).

### DNS server

Your LAN does not require a DNS server for CallPilot 100/150 to operate. However, a DNS server provides an easier interface to accessing the CallPilot Manager URL by providing a language-based name, such as CallPilot01. After this name is added to the DNS server as an alias for the system IP address, users can start CallPilot Manager by entering this name.

---

## Chapter 4

# Installing CallPilot 100/150

---

This chapter describes installing the CallPilot 100/150 on a wall and powering it up.

### Wall mounting the CallPilot 100/150

Follow this procedure to mount the CallPilot 100/150 on a wall.

- 1 Attach the wall mount bracket to a secure surface by the two inner holes. Use anchors, as necessary.
- 2 Slip the slot on the back (near the top) of the CallPilot 100/150 onto the bracket.
- 3 Secure the CallPilot 100/150 using a screw in the lower screw hole.

**Figure 2** Mounting the CallPilot 100/150

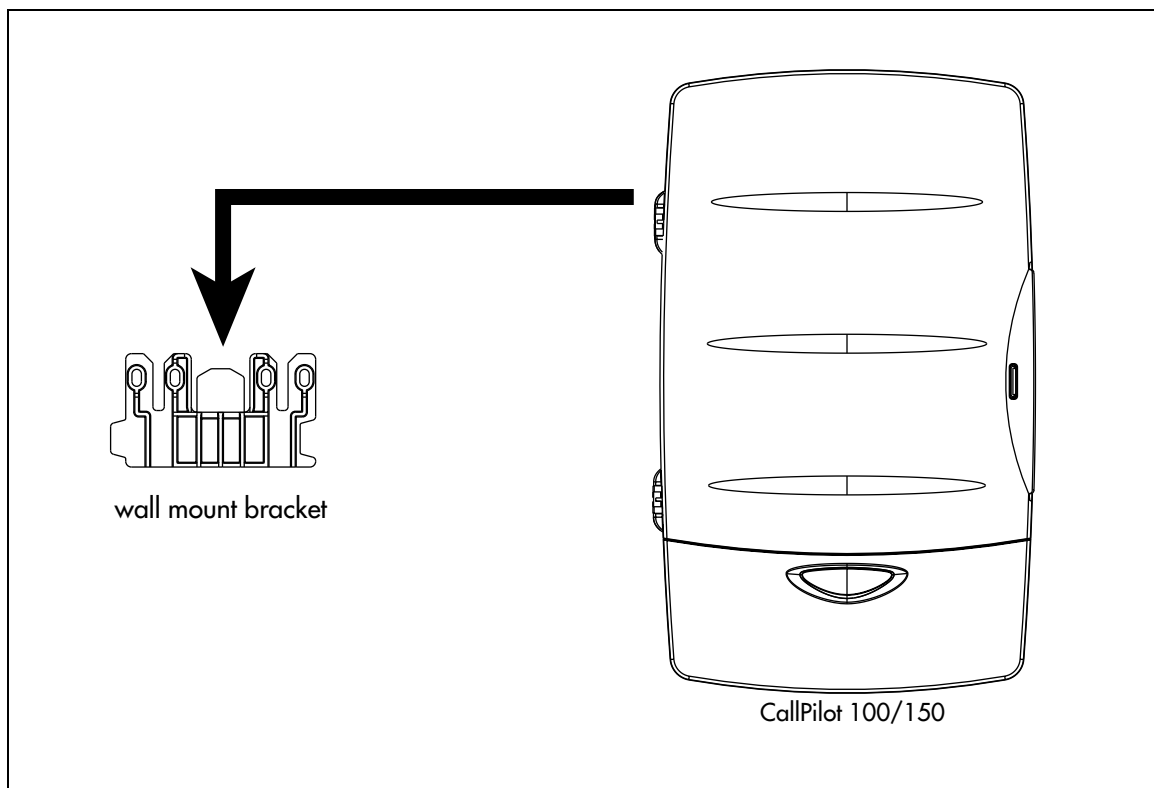

## Connecting the CallPilot 100/150

- 1 Open the CallPilot 100/150 by inserting a flat screwdriver into the slot on the right-hand side of the door and pressing the tab out of the way.

[Figure 3](#) shows the inside of the CallPilot housing and points out the cable jacks.

- 2 Connect a TCM cable to Port A and to Port B.  
[Table 4](#) shows the pin out of Port A and Port B.

**Table 4** Port A and Port B Pinouts

Pin number	CallPilot 100		CallPilot 150	
	Port A	Port B	Port A	Port B
1	no connection	no connection	no connection	no connection
2	no connection	no connection	TCM 3	TCM 4
3	TCM 1	TCM 2	TCM 1	TCM 2
4	TCM 1	TCM 2	TCM 1	TCM 2
5	no connection	no connection	TCM 3	TCM 4
6	no connection	no connection	no connection	no connection

- 3 Connect the other end of the TCM cables to station ports on your telephone system.



**Note:** Do not connect the Ethernet cable for your LAN to the Ethernet port until you determine if the CallPilot 100/150 IP address is compatible with the network. For information about the default CallPilot 100/150 IP address and how to change the IP address, refer to [“Connecting to the CallPilot 100/150” on page 31](#).

---

- 4 Connect the power cable to the CallPilot 100/150 and the wall socket.
- 5 Run all the cables through the cable trough at the top of the CallPilot 100/150.
- 6 Close the lid.





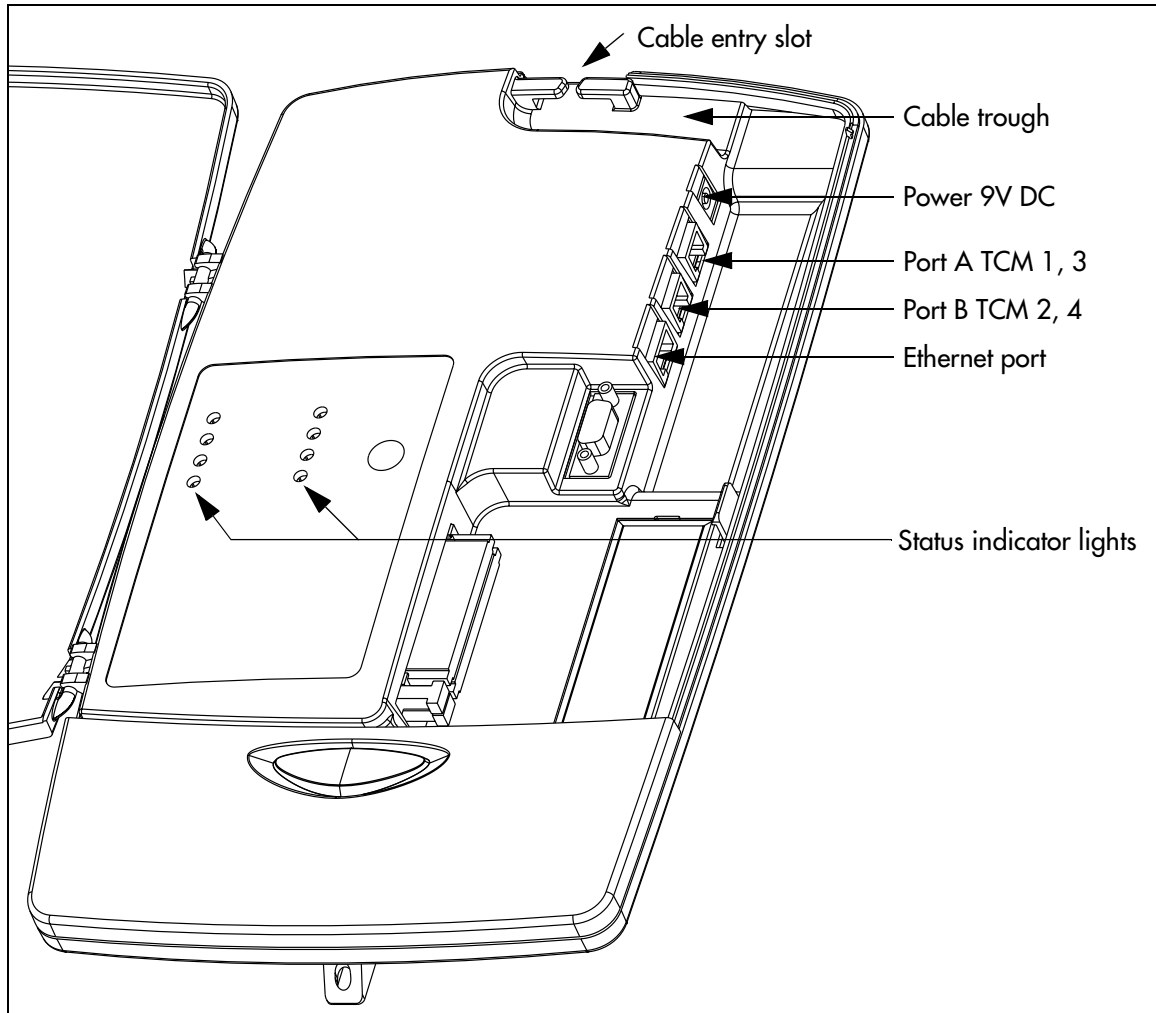

















Figure 3 CallPilot 100/150 connections



## CallPilot 100/150 LEDs



When the CallPilot 100/150 starts up, the LEDs change to indicate where the CallPilot 100/150 is in the start up process. [Table 5](#) shows the order in which the LEDs change and describes what each state indicates.

**Table 5** LEDs during startup







LEDs	Description	Indicates
	 1,  2,  3 and  4 turn on.	Power is connected to the CallPilot 100/150 and the RAM test is in progress.
	 1,  2,  3 and  4 turn off.	RAM test complete.
Click image for an example.	 1,  2,  3 and  4 turn on one at a time starting with  1. The LEDs continue to cycle on and off in this order.	The CallPilot 100/150 is being upgraded. <b>Note:</b> This sequence does not appear every time you restart CallPilot 100/150.
Click image for an example.	 1,  2,  3 and  4 turn on in order until all of the LEDs are on. The LEDs then turn off in the same order. The LEDs continue to cycle on and off in this order.	The CallPilot 100/150 is booting up.
	 1,  2,  3 and  4 turn off.	The CallPilot 100/150 has finished booting up. <b>Note:</b> The LEDs then light to indicate TCM connections as described in <a href="#">Table 6</a> .

When the CallPilot 100/150 is operating, the LEDs indicate the operating status of the CallPilot interfaces. [Table 6](#) describes the purpose of the LEDs.



**Note:** The CallPilot 100 does not have LEDs  3 and  4.

**Table 6** LEDs during operation

LED	Description	LED	Description
 4	LED lights when TCM channel 4 is connected to the telephone system.	<b>10/100</b>	LED lights when the Ethernet connection is operating at 100 Mbit/s and blinks with Ethernet activity.
 3	LED lights when TCM channel 3 is connected to the telephone system.		LED lights when the CallPilot 100/150 is operating.
 2	LED lights when TCM channel 2 is connected to the telephone system.		LED lights when an Ethernet connection is detected.
 1	LED lights when TCM channel 1 is connected to the telephone system.		Not used in this version of CallPilot 100/150.



**Note:** If the LAN interface is disabled with you startup CallPilot 100/150, the LED lights immediately, not after the CallPilot 100/150 is operating.





---

## Chapter 5

# Initializing the CallPilot 100/150

---

After you install and power up the CallPilot 100/150, you need to initialize it. Initializing the CallPilot 100/150 sets the system parameters to their default settings and sets some global parameters. When the initialization is completed, the CallPilot 100/150 is operational and ready for you to begin administration programming. Refer to [“Related publications” on page 12](#) for a list of documents that provide information about administration programming.

You initialize CallPilot 100/150 using CallPilot Manager or a telephone.



**Note:** Upgrading to CallPilot 100/150 from a previous voice messaging system.

If you are upgrading from a previous voice messaging system (for example, FlashTalk) to CallPilot 100/150, you must remove the existing Feature Codes for the old voice messaging system before you configure CallPilot 100/150. For information about how to remove the existing Feature Codes, refer to [“To remove Feature Codes” on page 64](#).

---

### About CallPilot Manager

CallPilot Manager is an application that you access from a web browser, such as Netscape® Communicator<sup>1</sup> or Microsoft® Internet Explorer<sup>2</sup>. Nortel Networks recommends you use CallPilot Manager whenever possible. CallPilot Manager provides access to administration programming not available from a telephone.



**Note:** The online Help for CallPilot Manager is best viewed in Internet Explorer. There can be some page format inconsistencies if you use other browsers.

---

To use CallPilot Manager, you must have a network connection to the CallPilot 100/150 or an Ethernet crossover cable. If you are using CallPilot Manager to initialize CallPilot 100/150, refer to [“Initializing CallPilot 100/150 using CallPilot Manager” on page 30](#).

If you do not have a network connection or an Ethernet crossover cable, you can initialize the CallPilot 100/150 using a two-line display telephone. If you are using a telephone to initialize CallPilot 100/150, refer to [“Initializing CallPilot 100/150 using a telephone” on page 38](#).

- 
- 1 Netscape is a registered trademark and Communicator is a trademark of Netscape Communications Corporation.
  - 2 Microsoft and Windows are registered trademarks and Internet Explorer is a trademark of Microsoft Corporation.
-

## Initializing CallPilot 100/150 using CallPilot Manager

To initialize CallPilot 100/150 using CallPilot Manager you need to:

- determine if your computer meets the CallPilot Manager requirements
- connect to the CallPilot 100/150
- run the Quick Install Wizard

### Computer requirements for CallPilot Manager

You access CallPilot Manager using a web browser on a computer that is connected to the CallPilot 100/150.

#### Computer requirements

The computer you use to access CallPilot Manager must be compatible with Microsoft® Windows® and capable of running your web browser.

#### Browser requirements

To use CallPilot Manager, you must have one of the following browsers:

- Netscape Communicator 4.5 or later
- Microsoft Internet Explorer 4.0 or later



**Note:** CallPilot Manager does not support Netscape 6.0.

---

## Connecting to the CallPilot 100/150

To connect to the CallPilot 100/150/CallPilot 100, you need the IP address of the CallPilot 100/150 and a connection to the network that the CallPilot 100/150 is on.

The default IP address for CallPilot 100/150 is 192.168.110.10.

If the default IP address is compatible with your network, you can connect the LAN cable to the Ethernet port on the CallPilot 100/150 and proceed to [“Running the Quick Install Wizard” on page 35](#).

If the default IP address is not compatible, you must change the IP address before you connect the CallPilot 100/150 to the network. You can change the IP address using a serial cable or an Ethernet crossover cable (direct PC connection).



**Note:** If you are unsure if the default IP address is compatible, contact your network administrator.

## Changing the IP address using a serial cable

If you are going to change the IP address using a serial cable, you need a:

- serial cable
- VT100-compatible terminal or a computer that has a VT100 compatible terminal emulation program such as HyperTerminal



**Note:** The serial port is intended for temporary connections only. After you have finished changing the IP address, remove the serial cable and close the CallPilot 100/150 door. Failure to remove the serial cable may result in a non-compliant EMC configuration.



**Note:** A serial cable is available as a separately available part. For information about obtaining a serial cable, contact your Nortel Networks supplier.

### *CallPilot 100/150 serial port*

The following table shows the pin out for the CallPilot 100/150 serial port.

**Table 7** CallPilot 100/150 serial port pinout

	Pin	Signal	Pin	Signal
	1	No connection	6	No connection
	2	Serial data in (RX)	7	No connection
	3	Serial data out (TX)	8	No connection
	4	No connection	9	No connection
	5	Ground		



**Note:** The location of the transmit (TX) and receive (RX) pins on your terminal can vary. Refer to your terminal or computer documentation to confirm pin locations.

---

### *Configuring the terminal*

The terminal or terminal emulation program you use must be VT100 compatible and must support the ASCII Character set. If the terminal does not support the ASCII Character set, the text displays incorrectly.

You must configure your terminal to the following communications parameters:

- 9600 bits per second
- 8 data bits
- no parity
- 1 stop bit
- no flow control

For information about how to set these parameters, refer to the documentation for your terminal or terminal emulation program.

### *Changing the IP address using the terminal*

To change the IP address:

- 1** Attach the serial cable to the serial port on the CallPilot 100/150. For information about the location of the serial port, refer to [Figure 3 on page 25](#).
- 2** Attach the other end of the cable to the serial port on the terminal or computer.
- 3** Ensure that your terminal or computer is powered up.
- 4** If you are using a computer, start your terminal emulation program.
- 5** Remove power from the CallPilot 100/150.



**Note:** Steps 5 and 6 are used to force the CallPilot 100/150 to reboot. You can change the IP address only while the CallPilot 100/150 is booting up.

---

- 6** Reconnect power to the CallPilot 100/150.

The prompt **To change any of this, press any key within 2 seconds** appears.



**Note:** It will take approximately one minute for this prompt to appear.

---



- 7 Press the **Enter** key.



**Note:** If you do not press a key within 2 seconds of this prompt appearing, repeat steps 5 and 6.

---

The prompt **(M)odify any of this or (C)ontinue?** appears.

- 8 Press the **M** key and press the **Enter** key.

The prompt **Do you want a LAN interface?** appears.

- 9 Press the **Y** key and press the **Enter** key.

The prompt **This board's LAN IP Address (0.0.0.0 = RARP)** appears.

- 10 Type the IP address for the CallPilot 100/150 in a valid dotted format and press the **Enter** key.

The prompt **Subnet mask for LAN (0 for none)** appears.

- 11 Type the Subnet Mask for the CallPilot 100/150 in a valid dotted format and press the **Enter** key.

The prompt **Should there be a default gateway for packet routing?** appears.

- 12 If the CallPilot 100/150 needs a next hop router, press the **Y** key and press the **Enter** key.  
If the CallPilot 100/150 does not need a next hop router, press the **N** key, press the **Enter** key and go to step 15.

The prompt **IP address of default gateway?** appears.

- 13 Type the IP address of the next hop router in a valid dotted format and press the **Enter** key.

- 14 Press the **Enter** key until the following prompt appears.

**(M)odify any of this or (C)ontinue?**

- 15 Press the **C** key and press the **Enter** key.

- 16 Connect the LAN cable to the Ethernet port on the CallPilot 100/150.

You can now initialize the CallPilot parameters. For information about how to initialize the CallPilot, refer to [“Running the Quick Install Wizard” on page 35](#).

### Changing the IP address using an Ethernet crossover cable

Using an Ethernet crossover cable, you can connect the CallPilot 100/150 to your computer. With this connection, you can use CallPilot Manager to change the CallPilot 100/150 IP address before you connect it to the network.



**Note:** If you do not have access to the CallPilot 100/150 through the network, you can use an Ethernet crossover cable to configure all of the CallPilot 100/150 parameters.

To use an Ethernet crossover cable, your computer must be equipped with a 10/100 BaseT Ethernet card and support TCP/IP protocol. [Figure 4](#) shows the connections required.

**Figure 4** Ethernet crossover cable

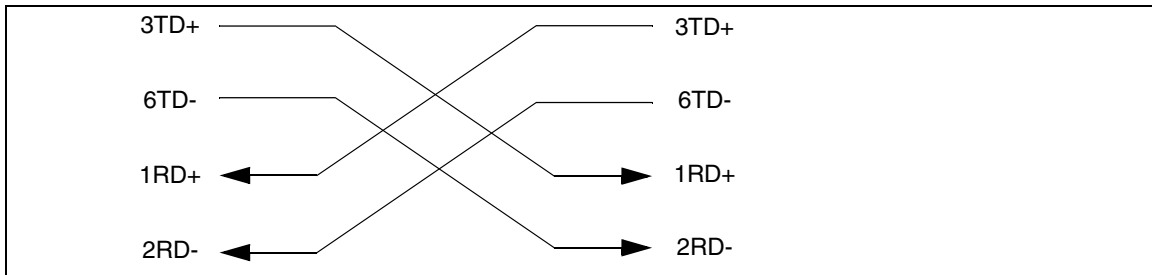

**Note:** An Ethernet crossover cable is available as a separately available part. For information about obtaining an Ethernet crossover cable, contact your Nortel Networks supplier.

#### *Connecting the Ethernet crossover cable*

- 1 Shut down the computer.
- 2 Attach one end of the Ethernet crossover cable to the Ethernet port on the CallPilot 100/150.
- 3 Connect the other end of the cable to the network interface card on your computer.
- 4 Start the computer.
- 5 Use the Quick Install Wizard to initialize the CallPilot 100/150.

For information about how to use the Quick Install Wizard, refer to [“Running the Quick Install Wizard”](#) on page 35.

## Running the Quick Install Wizard

The Quick Install Wizard appears the first time you startup CallPilot Manager. The Quick Install Wizard is a single page that gathers enough information to set up a working system. It then applies the information and restarts the system.

You can reach CallPilot Manager from another computer through a LAN connection, WAN/Internet connection or an Ethernet crossover cable. All of these methods create an IP connection that allows you to run CallPilot Manager.

Use the following procedure to run the Quick Install Wizard:

- 1 Launch your browser.
- 2 In the URL address box, type the CallPilot 100/150 IP address.  
For example: **HTTP://192.168.110.10**



**Note:** You must include **HTTP://** to access CallPilot Manager.

The Quick Install Wizard screen appears. Depending on your system, this can take several minutes to appear.

- 3 Configure the Quick Install parameters for a CallPilot 100/150 according to [Table 8 on page 35](#).

**Table 8** Quick Install Wizard parameters for a CallPilot 100/150

Field name	Description
IP Address	Enter the IP Address for the CallPilot 100/150. If you do not know the IP Address, contact your network administrator. This is the IP Address you will use to access the CallPilot 100/150 using CallPilot Manager. Changes to the IP Address take effect when you reboot the CallPilot 100/150. If this is a re-install, the IP Address shows the current settings, not the factory default.
Subnet Mask	Enter the Subnet Mask for the CallPilot 100/150. If you do not know the Subnet Mask, contact your network administrator. Changes to the Subnet Mask take effect when you reboot the CallPilot 100/150. If this is a re-install, the Subnet Mask shows the current settings, not the factory default.
Primary DNS	Enter the IP Address of the Primary DNS server that CallPilot 100/150 uses. If you do not know the IP Address, contact your network administrator. The Primary DNS server allows you to use domain names, such as www.nortelnetworks.com, instead of IP addresses when accessing a site. <b>Note:</b> If you do not use DNS, leave this box blank. CallPilot applications, such as Digital Networking, can use a DNS server even if you leave this box blank.
Secondary DNS	Enter the IP Address of the Secondary DNS server that CallPilot 100/150 uses. If you do not know the IP Address, contact your network administrator. CallPilot 100/150 uses the Secondary DNS server if it cannot contact the Primary DNS server or if the domain name is not listed in the Primary DNS server. <b>Note:</b> If you do not use DNS, leave this box blank. CallPilot applications, such as Digital Networking, can use a DNS server even if you leave this box blank.

Field name	Description
Default Gateway	Enter the IP Address of the default next-hop router. If you do not know the IP Address, contact your network administrator. <b>Note:</b> If you do not require a next-hop router, leave this box blank.
Base Application	The default base application is voicemail. If you want the base application to be Call Center, click the <b>CallCenter</b> button.  If you select voicemail: <ul style="list-style-type: none"> <li>• the voicemail application is enabled</li> <li>• 20 mailboxes are enabled on the CallPilot 150</li> <li>• 10 mailboxes are enabled on the CallPilot 100.</li> </ul> If you select Call Center: <ul style="list-style-type: none"> <li>• no mailboxes are enabled</li> <li>• the Call Center application is enabled</li> <li>• 20 agents are enabled (10 agents are active)</li> <li>• the mailbox and lines administration sections are removed from the Quick Install Wizard screen.</li> </ul>
Attendant DN	Enter the extension number of the CallPilot attendant.
Primary UI Style	Select the user interface style assigned to the mailboxes. You can select NVM or CallPilot. If you select NVM, the mailbox user interface operates like Norstar Voice Mail and FlashTalk. Users will hear Norstar Voice Mail voice prompts and see Norstar Voice Mail text prompts. If you select CallPilot, the mailbox user interface operates like Meridian 1 CallPilot. Users will hear CallPilot voice prompts and see text prompts for CallPilot. You can change the UI style of individual mailboxes by assigning a different Class of Service to those mailboxes.
Primary Language	Select the default language that is used for voice prompts, text messages, the Auto-Attendant and Feature 983 administration. You can change the language of individual mailboxes by assigning a different Class of Service to those mailboxes.
Country	Select the country in which the CallPilot 100/150 is installed. The country you select determines several country specific settings such as the telephone number length, mailbox login sequence and Call Progress Tone Detection. You must select the country that the CallPilot 100/150 is in to ensure proper operation. The default is North America.
From Line	Enter the line number of the first line in a range of lines that you want the auto-attendant to answer. The auto-attendant answers this line and all of the lines up to the line number you enter in the To Line box.
To Line	Enter the line number of the last line in a range of lines you want the auto-attendant to answer. The line number you enter in this box must be the same or higher than the line number you enter in the From Line box.
Number of rings	Enter the number of rings that CallPilot waits before answering a line.

Field name	Description
Mailbox Keycode	<p>If you have purchased additional mailboxes for CallPilot , enter the keycode you received with your mailbox package.</p> <p>If you have not purchased additional mailboxes, leave these boxes empty.</p> <p>Use these boxes only for the keycode for additional mailboxes. Do not enter the keycode that enables the basic voicemail application.</p>
From Extension	<p>Enter the extension number of the first telephone in a range of telephones you want to create a mailbox for.</p> <p>A mailbox is created for this telephone and for all of the telephones up to the extension number you enter in the To Extension box.</p> <p>The mailboxes are named according the set name of the telephone and assigned Class of Service 1.</p>
To Extension	<p>Enter the extension number of the last telephone in a range of telephones you want to create a mailbox for.</p> <p>The extension number you enter in this box must be the same or higher than the extension number you enter in the From Extension box.</p>
Outdial Method	<p>Select the outdial method you want to assign to the mailboxes created using the From Extension and To Extension boxes. You can choose None, Line, Pool or Route.</p> <p>If you select <b>None</b>, no outdial method is assigned to the mailboxes.</p> <p>If you select <b>Line</b>, click the Outdial Method text box and enter the line number of the line you want assign to the mailboxes.</p> <p>If you select <b>Pool</b>, click the Outdial Method text box and enter the line pool number of the line pool you want to assign to the mailboxes.</p> <p><b>Note:</b> Line pool numbers 0 to 15 correspond to the Line Pools A to O on the KSU programming interface.</p> <p>If you select <b>Route</b>, click the Outdial Method text box and enter the route number of the route you want to assign to the mailboxes.</p>

#### 4 Click the **Install** button.

You can now start programming the CallPilot parameters. For information about how to program CallPilot , refer to the *CallPilot Manager Set Up and Operation Guide*.



**Note:** If you have changed any of the IP addresses or the Subnet Mask, you must reboot the CallPilot 100/150 before you start programming the CallPilot parameters.

## Initializing CallPilot 100/150 using a telephone

To initialize CallPilot 100/150 you need to:

- determine the CallPilot 100/150 Feature Codes
- configure the CallPilot 100/150 initial parameters



**Note:** If you initialized CallPilot 100/150 using CallPilot Manager, you do not need to initialize CallPilot 100/150 using a telephone.

### Determining CallPilot 100/150 Feature Codes

Default Feature Codes are assigned to CallPilot 100/150 by the Norstar system. These default codes are listed in [Table 9](#). When these default Feature Codes are used by other Norstar applications, the Norstar system assigns Feature Codes between 900 and 999 to CallPilot 100/150. These codes might not be assigned in sequential order. Record the assigned Feature Codes on [Table 9](#).

**Table 9** Assigned Feature Codes

Feature Code name	Default	Number	Used By
Agent Login	☎ 9 0 4	☎ 9 _____	Call Center only
Busy Mode	☎ 9 0 8	☎ 9 _____	Call Center only
Queue Status	☎ 9 0 9	☎ 9 _____	Call Center only
Leave Message	☎ 9 8 0	☎ 9 _____	Call Center and Voicemail
Open Mailbox	☎ 9 8 1	☎ 9 _____	Call Center and Voicemail
Operator/Service Control	☎ 9 8 2	☎ 9 _____	Call Center and Voicemail
System Administration	☎ 9 8 3	☎ 9 _____	Call Center and Voicemail
Call Forward to Voicemail	☎ 9 8 4	☎ 9 _____	Call Center and Voicemail
CallPilot DN	☎ 9 8 5	☎ 9 _____	Call Center and Voicemail
Transfer to Voicemail	☎ 9 8 6	☎ 9 _____	Call Center and Voicemail
Interrupt	☎ 9 8 7	☎ 9 _____	Call Center and Voicemail
Name Dial	☎ 9 8 8	☎ 9 _____	Call Center and Voicemail
Record Call	☎ 9 8 9	☎ 9 _____	Call Center and Voicemail

Follow this procedure to determine CallPilot Feature Codes:

- 1 Press ☎ 9 \* 1 on a two-line display telephone.
- 2 Record the Feature Code for the first feature used by CallPilot in [Table 9](#) and on the *CallPilot Programming Record* or the *Call Center Programming Record*.

- 3 Press NEXT to show the next Feature Code used by CallPilot . Record this code in [Table 9](#) and on the *CallPilot Programming Record* or the *Call Center Programming Record*.
- 4 Repeat step 3 until you reach the final Feature Code.
- 5 Press QUIT to end this session.

## Configuring the CallPilot 100/150 initial parameters

To configure the CallPilot 100/150 initial parameters:

1. Press .

This is the default System Administration feature code. If your system does not use the default feature codes, enter the System Administration feature code you determined earlier.

```
Pswd:
RETRY      OK
```

2. Enter  (CONFIG) and press OK.

```
App:voicemail
CHNG      NEXT
```

3. Press CHNG to toggle the settings between `voicemail` or `CallCenter`.

If you choose `voicemail`:

- the voicemail application is enabled
- 20 mailboxes are enabled on CallPilot 150
- 10 mailboxes are enabled on CallPilot 100

If you choose `CallCenter`:

- the Call Center application is enabled
- 20 agents are enabled (10 agents are active)
- no mailboxes are enabled

4. Press NEXT.

```
Bilingual?
YES      NO
```

5. Press Y if you want the display and voice prompts to be available in two languages.

Press N if you want the display and voice prompts to be available in one language.

When you choose N (No) for the Bilingual option, step 6 is not required and the system automatically goes to step 7.

Primary lang?  
ENG FRE

6. Press the button for the language you want as the Primary Language.

Group lists? Y  
CHNG NEXT

7. Press CHNG to toggle the settings between Y for Yes, or N for No.

8. Press NEXT.

When you choose N (No) for the enable Group List option, steps 9 and 10 are not required and the system automatically goes to step 11.

Leading digit: 9  
CHNG NEXT

9. Press CHNG to enter a new Group List leading digit.

The Group List leading digit can be any number from 0 to 9. Special Mailbox numbers automatically begin with 1, so if you select a Group List leading digit of 1, the Special Mailboxes will begin with 2. The Group List Leading Digit cannot be the same as the first number of any mailbox.

10. Press NEXT.

CallPilot UI: Y  
CHNG NEXT

11. Press CHNG to toggle the settings between Y for Yes, or N for No.

12. Press NEXT.

Primary UI: NUM  
CHNG NEXT

13. Press CHNG to toggle the setting between NUM and CP.

If you choose NVM, the mailbox users will see and hear Norstar Voice Mail prompts when they use their mailboxes. If you choose CP, the mailbox users will see and hear CallPilot prompts when they use their mailboxes.

14. Press NEXT.

System config  
RETRY OK

15. Press OK.

Configuring...

This message appears on the display.



System ready

Initialization takes about three seconds. When complete, the display shows: `System ready` and `Exit`.

Exit

After the initialization programming is completed, the display automatically returns to the time and date.

You can now start programming the CallPilot parameters. For information about how to program the CallPilot, refer to the *CallPilot 100/150 Telephone Administration Guide*.



---

## Chapter 6

# Language Configuration Utility

---

The CallPilot 100/150 has two languages available for text and voice prompts. The Language Configuration Utility allows you to change the two languages that are available.

The computer you use to run the Language Configuration Utility must be compatible with Microsoft® Windows® and have a network connection to the CallPilot 100/150.

## Changing the languages available

To change the available languages:

- 1** Load the CallPilot CD in the CD-ROM drive of your computer.
- 2** Open the CD folder and open the **Optional Software** folder.
- 3** Open the **Language Utility** folder.
- 4** Double click the **CallPilotLangConfig.exe** file.  
The CallPilot Language Configuration screen appears.
- 5** Select the **Server name** option or the **Server IP Address** option.
- 6** If you selected the **Server name** option, enter the fully qualified domain name for the CallPilot 100/150/CallPilot 100.  
If you selected the **Server IP Address** option, enter the IP address of the CallPilot 100/150 in standard dotted format.
- 7** Click the **Next** button.  
The Language Configuration Utility attempts to connect to the CallPilot 100/150. If the connection is successful, the Language Selection options appear.
- 8** Click the **Specify the language to remove** drop list.  
The two languages available on the CallPilot 100/150 appear.
- 9** Click the language you want to remove.
- 10** Click the **Specify the language to install** drop list.  
The languages available to install appear.
- 11** Click the new language you want to install on the CallPilot 100/150.
- 12** Click the **Browse** button.  
The Save As dialog box appears.
- 13** Move to the location where the language you want to install is located and click on the language file.
- 14** Click the **OK** button.  
The Summary information screen appears.
- 15** Check the information that appears on this screen.  
If the information is correct, click the **Finish** button.

If the information is not correct, click the **Back** button and correct the information before proceeding.

A dialog box appears when the language change is completed.

- 16** Click the **OK** button.
- 17** If you want to change the second language, repeat steps 4 to 16 for the second language.
- 18** Reboot the CallPilot 100/150 by removing the power cable from the CallPilot 100/150, waiting 30 seconds and then reconnecting the power cable.

---

## Chapter 7

# Password administration

---

## Resetting passwords

This section identifies each type of CallPilot password and how to reset it if the owner forgets it.

### Resetting the system administrator password

This is the password the system administrator uses to reach the administrative functions, including resetting other passwords. The default is 0000. The system makes the users reset their passwords the first time they access their mailboxes through the telephone interface.

Use this procedure to reset the system administrator password using a telephone with the CallPilot User Interface:

- 1 Dial in to CallPilot system.
- 2 Ask the CallPilot Attendant to transfer you, or use the Automated Attendant to transfer yourself, to the General Delivery Mailbox.
- 3 Log on to the General Delivery Mailbox using the general delivery mailbox number and password.
- 4 Enter the telephone number of the modem on the support computer.
- 5 Press **8 0 8**.
- 6 Press **7 3 7 3 8 7 6 7 7 9 3** (R E S E T S M P S W D).



**Note:** You must be using the CallPilot User Interface to reset the password using **8 0 8**. If you are using the Norstar Voice Mail User Interface, use **6 9 8 5** to reset the password.

---

Use this procedure to reset the system administrator password using a telephone with the Norstar User Interface.

1. Press **6 9 8 5**.

Set: xxxx  
NEXT

2. Press **9**.

Pswd:  
RETRY OK

3. Press **7 3 7 3 8 7 6 7 7 9 3**  
(R E S E T S M P S W D) and press **OK** or **#**.

Reset Password:  
YES NO

4. Press **YES** or **#**.

## Resetting the operator password

The operator password is used to gain access to operator manager functions, such as open and close business, change attendant DNs and enable and disable call answering.

### Resetting the password using CallPilot Manager

- 1 Log on to CallPilot Manager.
- 2 Click the **Operations** heading.
- 3 Click the **Operator Settings** link.
- 4 Select the **Reset Operator Password** check box.
- 5 Click the **Submit** button.

The password resets to 67372867 (operator).

### Resetting the password using a telephone

Use this procedure to reset the operator password using a telephone with the CallPilot User Interface:

- 1 Dial in to CallPilot system.
- 2 Ask the CallPilot Attendant to transfer you, or use the Automated Attendant to transfer yourself, to the General Delivery Mailbox.
- 3 Log on to the General Delivery Mailbox using the general delivery mailbox number and password.
- 4 Press **8 0 8**.
- 5 Press **7 3 7 3 8 6 7 3 7 7 7 9 3** (R E S E T O P E R P S W D).



**Note:** You must be using the CallPilot User Interface to reset the password using **8 0 8**. If you are using the Norstar Voice Mail User Interface, use **9 8 5** to reset the password.

Use this procedure to reset the operator password using a telephone with the NorstarVoice Mail User Interface.

1. Press **9 8 5**.

Set: xxxx  
NEXT

2. Press **7**.

Pswd:  
RETRY OK

3. Press **7 3 7 3 8 6 7 3 7 7 7 9 3** (R E S E T O P E R P S W D) and press **OK** or **#**.

Reset Password:  
YES NO

4. Choose **YES** or **#**.

## Resetting the Mailbox passwords

The Mailbox password allows users to access their mailbox.

### Resetting the password using CallPilot Manager

- 1 Log on to CallPilot Manager.
- 2 Click the **Mailbox Administration** heading.
- 3 Click the **Change/Delete Mailbox** link.
- 4 Click the **Reset Password** link by the mailbox for which you are resetting the password.  
A confirmation dialog box appears.
- 5 Click the **OK** button.

The password resets to 0000.

### Resetting the password using a telephone

Follow this procedure to reset a mailbox password using a telephone.

1. Press **[\*] 9 8 3**.
2. Enter the system administration mailbox number and password.
3. Press **MBOX**.
4. Press **CHNG**.
5. Enter the number of the mailbox you wish to change.
6. Press **Next** until **Password** appears on the display.
7. Press **RESET**.
8. Press **[#]**.

```
Log:
QUIT  REPLY  OK
```

```
Admin
MBOX  AA  OTHR
```

```
Mailbox Admin
ADD  DEL  CHNG
```

```
Mbox:
DIR           QUIT
```

```
Password:
RESET      NEXT
```

## Resetting the Call Center Administrator password

This password is used to access CallPilot Manager to administer the Call Center software.

- 1 Log on to CallPilot Manager.
- 2 Click the **Configuration** heading.
- 3 Click the **Access Passwords** link.
- 4 Enter a new password into the **Call Center Administration Password** box.
- 5 Enter the password again in the **Confirmation** box.
- 6 Click the **Submit** button.

## Resetting the Modem access password

This password is used to access CallPilot over a dialup connection.

- 1 Log on to CallPilot Manager.
- 2 Click the **Configuration** heading.
- 3 Click the **Access Passwords** link.
- 4 Enter a new password into the **Modem Access** box.
- 5 Enter the password again in the **Confirmation** box.
- 6 Click the **Submit** button.



**Note:** The Modem access password cannot be the same as the System Administrator password.

## Resetting the Modem access password using a telephone

Follow this procedure to reset the Modem access password using a telephone.

1. Press    .

```
Log:
QUIT RETRY OK
```

2. Enter the system administration mailbox number and password.

```
Admin
MBOX AA OTHR
```

3. Press .

```
Voice Mail:Y
CHNG NEXT
```

4. Press NEXT.

```
Dir avail:Y
CHNG NEXT
```

5. Press NEXT.

```
Match:Lastname
CHNG OK
```

6. Press OK.



Modem access:Y  
CHNG OK

7. Press CHNG.

Modem access:N  
CHNG OK

8. Press CHNG.

Pswd:  
RETRY OK

9. Enter the new Modem access password and press OK.

Again:  
RETRY OK

10. Re-enter the new Modem access password and press OK.

11. Press .



---

## Chapter 8

# Backing up and restoring CallPilot

---

Using the CallPilot tools, you can:

- back up CallPilot information
- restore CallPilot information
- retrieve the CallPilot log files

To use these features, you must install the CallPilot Backup and Restore Utility on your computer.



**Note:** You must have Windows 95 or later installed on your computer to run the CallPilot Backup and Restore Utility.

---

## Installing the CallPilot Backup and Restore Utility

To install the CallPilot Backup and Restore Utility:

- 1 Load the CallPilot CD in the CD-ROM drive of your computer.
- 2 Open the CD folder and open the **Optional Software** folder.
- 3 Open the **BRU Utility** folder.
- 4 Copy the file **CallPilotBRU.exe** to a folder on your computer.
- 5 Remove the CallPilot CD from your computer.

## Backing up the CallPilot information

Backing up the CallPilot information is a method of protecting your CallPilot programming, voice messages and greetings. When you back up CallPilot, you make a copy the CallPilot information and store it in a directory on your computer. If your CallPilot 100/150 must be replaced or loses its programming, you can restore this back up information to your CallPilot 100/150.



**Note:** Nortel Networks recommends that you perform a back up after you have completed your initial programming. We also recommend that you back up on a regular basis to save new programming, greetings and voice messages.

You must install the CallPilot Backup and Restore Utility on the computer you are using to back up the CallPilot information.

---

Before you backup the CallPilot information, make sure you have enough disk space available on the disk you are using to store the backup information. [Table 10](#) shows the maximum amount of disk space required for each backup.

**Table 10** Maximum disk space required to backup CallPilot 100/150

Type of CallPilot system	Maximum disk space required
CallPilot 100	40 MB
CallPilot 150	85 MB
CallPilot 150 (with optional message storage upgrade)	180 MB



**Caution:** Do not use CallPilot Manager to perform any administrative tasks while a backup is in progress. If you use CallPilot Manager to make a change during a backup, the CallPilot 100/150 can become corrupted and inoperable.

To help prevent other people from making changes during a backup, inform anyone with administrative privileges that you are doing a backup and that they should not access CallPilot Manager until the backup is completed.

To back up the CallPilot information:

- 1 Start your web browser.
- 2 Log on to CallPilot Manager.
- 3 Click the **Operations** heading.
- 4 Click the **Backup/Restore** link.
- 5 Click the **Proceed** button.



**Note:** When you click the Proceed button to start a back up, the CallPilot 100/150 shuts down and drops all of the users accessing CallPilot. This includes users accessing their mailboxes, callers leaving a message and callers waiting in Call Center Skillssets.

Make sure that there is no one using the CallPilot 100/150 before you start the back up. For information about how to determine if the CallPilot ports are busy, refer to [“Programming CallPilot 100/150 DNs to memory buttons”](#) on page 80.

- 6 Close your web browser window.



**Note:** To ensure proper operation, you must close the web browser window .

- 7 If you have a connection to the CallPilot Modem, make sure you disconnect the modem before starting the CallPilot Backup and Restore Utility.
- 8 Create a directory on your computer where you want to store the CallPilot information.

- 9 Start the CallPilot Backup and Restore Utility (CallPilotBRU.exe).  
The CallPilot Backup/Restore Utility screen appears.
- 10 Click the **Backup** option.
- 11 In the **Local Folder** box, enter the path name of the directory on your computer in which you want to store the CallPilot information.
- 12 In the **CallPilot 150 hostname or IP addresses** box, enter the host name or IP address of the CallPilot 100/150/CallPilot 100 you want to backup.
- 13 Click the **OK** button.  
A confirmation dialog box appears.
- 14 If the information on the confirmation dialog is correct, click the **Continue** button.  
If the information is not correct, click the **Cancel** button and repeat steps 10 to 12.  
  
A dialog box appears when the backup is completed.
- 15 Click the **Continue** button.
- 16 Reboot the CallPilot 100/150/CallPilot 100

## Restoring the CallPilot information

If your CallPilot 100/150 has been replaced or has lost its programming information, you can restore the CallPilot programming, greetings and voice messages from a previous back up.



**Note:** You must have a back up of the CallPilot information stored on your computer to perform a restore.

You must install the CallPilot Backup and Restore Utility on the computer you are using to restore the CallPilot information.

---



**Caution:** Do not use CallPilot Manager to perform any administrative tasks while a restore is in progress. If you use CallPilot Manager to make a change during a restore, the CallPilot 100/150 can become corrupted and inoperable.

To help prevent other people from making changes during a restore, inform anyone with administrative privileges that you are doing a restore and that they should not access CallPilot Manager until the restore is completed.

---



**Note:** Check the Country and Language settings on the CallPilot 100/150 before starting the Restore. The Country and Language settings must be the same as the backup CallPilot information you are restoring.

If the Country setting is different than the backup, use CallPilot Manager to change the language to match the backup CallPilot information. For information about how to change the Country settings, refer to the *CallPilot Manager Set Up and Operation Guide*.

If the Language settings are different than the backup, use the Language Configuration Utility to change the languages to match the backup CallPilot information. For information about how to use the Language Configuration Utility, refer to “[Language Configuration Utility](#)” on page 43.

---

To restore the CallPilot information:

- 1 Start your web browser.
- 2 Log on to CallPilot Manager.
- 3 Click the **Operations** heading.
- 4 Click the **Backup/Restore** link.
- 5 Click the **Proceed** button.



**Note:** When you click the Proceed button to start a restore, the CallPilot 100/150 shuts down and drops all of the users accessing CallPilot. This includes users accessing their mailboxes, callers leaving a message and callers waiting in Call Center Skillsets.

Make sure that there is no one using the CallPilot 100/150 before you start the restore. For information about how to determine if the CallPilot ports are busy, refer to “[Programming CallPilot 100/150 DN to memory buttons](#)” on page 80.

---

- 6 Close your web browser.



**Note:** To ensure proper operation, you must close the web browser window.

---

- 7 If you have a connection to the CallPilot Modem, make sure you disconnect the modem before starting the CallPilot Backup and Restore Utility.
- 8 Start the CallPilot Backup and Restore Utility (CallPilotBRU.exe). The CallPilot Backup/Restore Utility screen appears.
- 9 Click the **Restore** option.
- 10 In the **Local Folder** box, enter the path name of the directory on your computer in which the CallPilot backup information is stored.
- 11 In the **CallPilot 150 hostname or IP addresses** box, enter the host name or IP address of the CallPilot 100/150 to which you want to restore information.

- 12** Click the **OK** button.  
A confirmation dialog box appears.
- 13** If the information on the confirmation dialog is correct, click the **Continue** button.  
If the information is not correct, click the **Cancel** button and repeat steps 9 to 11.  
  
A dialog box appears when the restore is completed.
- 14** Click the **Continue** button.
- 15** Reboot the CallPilot 100/150.

## Retrieving the CallPilot log files

The CallPilot log files are a tool used by your Nortel Networks representative to help diagnose a CallPilot problem.



**Note:** The information in the log files is intended for Nortel Networks service representatives. You will need the assistance of a service representative to interpret the information contained in these files.

You must install the CallPilot Backup and Restore Utility on the computer you are using to retrieve the log files.

---

To retrieve the CallPilot log files:

- 1** Create a directory on your computer where you want to store the CallPilot log files.
- 2** If you have a connection to the CallPilot Modem, make sure you disconnect the modem before starting the CallPilot Backup and Restore Utility.
- 3** Start the CallPilot Backup and Restore Utility (CallPilotBRU.exe).  
The CallPilot Backup/Restore Utility screen appears.
- 4** Click the **Log Files** option.
- 5** In the **Local Folder** box, enter the path name of the directory on your computer in which you want to store the CallPilot Log Files.
- 6** In the **CallPilot 150 hostname or IP addresses** box, enter the host name or IP address of the CallPilot 100/150 from which you want to retrieve the log files.
- 7** Click the **OK** button.  
A confirmation dialog box appears.
- 8** If the information on the confirmation dialog is correct, click the **Continue** button.  
If the information is not correct, click the **Cancel** button and repeat steps 4 to 6.  
  
A dialog box appears when the Log files have been copied onto your computer. It will take several minutes to copy the CallPilot log files to your computer.
- 9** Click the **OK** button.





---

## Chapter 9

# Upgrading CallPilot 100/150

---

This section describes how to upgrade the CallPilot 100/150. You can upgrade:

- the CallPilot software
- the message storage on a CallPilot 100/150



**Note:** You cannot upgrade the message storage of a CallPilot 100. You cannot upgrade from a CallPilot 100 to a CallPilot 150.

---

## Upgrading the CallPilot software version

Make sure that there is no one using the CallPilot 100/150 before you start the upgrade. For information about how to determine if the CallPilot ports are busy, refer to [“Programming CallPilot 100/150 DN’s to memory buttons” on page 80](#).

- 1 Nortel Networks recommends that you backup your CallPilot information before you upgrade the CallPilot software. For information about how to backup CallPilot, refer to [“Backing up the CallPilot information” on page 51](#).
- 2 Put on an anti-static strap and connect it to a grounded metal object.
- 3 Unplug the power connector from the CallPilot 100/150.
- 4 Insert the upgrade cartridge in the top PCMCIA slot.

For the location of the PCMCIA slots, refer to [Figure 1 on page 19](#).





**Caution:** The upgrade cartridge must be inserted in the top PCMCIA slot. If the upgrade cartridge is inserted in the bottom PCMCIA slot, your current software overwrites the upgrade cartridge and all of your programming is lost. Contact your Nortel Networks Service Representative for assistance.

**Caution:** Never install the upgrade cartridge or the feature cartridge in any device other than the CallPilot 100/150. These cartridges can be corrupted by inserting them in other devices.

---

- 5 Restore power to the unit.





The CallPilot 100/150 starts up. During the start up, the LEDs turn on and off in the following sequence:

-  LEDs 1 to 4 light for approximately 20 seconds
-  LEDs 1 to 4 turn off for approximately 25 seconds



**Note:** On the CallPilot 100, only  LEDs 1 and 2 turn on and off during the software upgrade.

---

- 6 The CallPilot 100/150 copies the files from the upgrade cartridge to the feature cartridge. During the upgrade, the LEDs turn on and off in the following sequence:
  -  LEDs 1 to 4 cycle on and off, one at a time, for approximately 8 to 10 minutes
  -  LEDs 1 to 4 turn off for approximately 40 seconds
  - some or all of the  LEDs 1 to 4 may light to indicate TCM connections to the CallPilot on these ports
- 7 Wait until the  LED turns on.
- 8 Unplug the power connector from the CallPilot 100/150.
- 9 Press the eject button on the top PCMCIA slot to remove the upgrade cartridge.



**Note:** When removing the upgrade cartridge, be careful not to dislodge the feature cartridge in the bottom slot. If the feature cartridge becomes dislodged, ensure it is fully inserted before you restore power.

---

- 10 Restore power to the CallPilot 100/150.

The CallPilot 100/150 will reboot. At this point it begins any necessary conversions.
- 11 If necessary, you can restore your CallPilot information. For information about how to restore the CallPilot information, refer to [“Restoring the CallPilot information” on page 53](#).

## Upgrading the message storage

Message storage is the amount of memory available on your CallPilot system to store greetings and voice mail messages. You can upgrade the message storage on your CallPilot 150 from 24 hours to 59 hours.



**Note:** You cannot upgrade the message storage time on a CallPilot 100.

---

To upgrade the message storage, you replace the existing feature cartridge with the expanded memory feature cartridge. Contact your Nortel Networks sales representative for information on how to obtain an expanded memory feature cartridge.

To upgrade the message storage:

- 1 Backup your CallPilot information. For information about how to backup CallPilot, refer to [“Backing up the CallPilot information” on page 51](#).
- 2 Put on an anti-static strap and connect it to a grounded metal object.
- 3 Unplug the power connector from the CallPilot 150.
- 4 Press the eject button on the bottom PCMCIA slot to remove the feature cartridge.

- 5 Insert the new feature cartridge into the bottom PCMCIA slot.







For the location of the PCMCIA slots, refer to [Figure 1 on page 19](#).

- 6 Connect power to the CallPilot 150.

The CallPilot 100/150 will reboot.



**Note:** A correct reboot of the CallPilot 150 is indicated by the following LED sequence:

-  LEDs 1 to 4 light for approximately 20 seconds
-  LEDs 1 to 4 turn off for approximately 25 seconds
-  LEDs 1 to 4 blink rapidly for approximately 30 seconds
-  LEDs 1 to 4 turn off for approximately 50 seconds
- some or all of the  LEDs 1 to 4 may light to indicate TCM connections to the CallPilot on these ports
-  LED lights to indicate that CallPilot is operating normally

If the CallPilot 150 does not reboot, make sure the feature cartridge is in the bottom PCMCIA slot and is properly seated. If the feature cartridge is not inserted properly, disconnect the power from the CallPilot 150, insert the feature cartridge in the bottom slot and restore power.

---

- 7 Use CallPilot Manager to change the **Country** setting to the country that was selected before the upgrade. For information about how to change the Country settings, refer to the *CallPilot Manager Set Up and Operation Guide*.
- 8 Use the Language Configuration Utility to change the Languages settings to the languages that were selected before the upgrade. For information about how to use the Language Configuration Utility, refer to [“Language Configuration Utility” on page 43](#).
- 9 Restore your CallPilot information. For information about how to restore the CallPilot information, refer to [“Restoring the CallPilot information” on page 53](#).



---

# Chapter 10

## Troubleshooting

---

### Introduction

Troubleshooting CallPilot 100/150 problems involves determining the symptoms and diagnosing the cause of the problem.

A problem can be the result of more than one component failure. Diagnosing a CallPilot 100/150 problem involves isolating the cause, and determining whether the malfunction involves a failed hardware component or the CallPilot 100/150 software configuration.

**Important:** After you have determined the cause of the problem, and corrected the problem by replacing a component or changing the software configuration parameters, you must test the CallPilot 100/150.

### Diagnosing problems

A malfunctioning CallPilot 100/150 can be caused by a faulty component or the CallPilot 100/150 software configuration. The following sections describe the symptoms that occur when CallPilot 100/150 malfunctions. The symptoms are described first, followed by the procedures to confirm and correct the problem.

#### The RS-232 terminal cannot communicate with CallPilot 100/150

Communication problems appear as garbled text or a blank screen. You need to determine if the problem is a communication problem, or if CallPilot 100/150 is not working at all.

Check to see if CallPilot 100/150 responds to the Feature Codes.

Press **☎** **9** **8** **1** on any Norstar telephone connected to the system. CallPilot 100/150 should respond with the **Pswd:** display prompt. The **Log:** display prompt can also appear if the telephone is not assigned a mailbox.



**Note:** CallPilot 100/150 Feature Codes might not be the default codes shown here. For more information on determining CallPilot 100/150 feature codes, refer to [“Determining CallPilot 100/150 Feature Codes”](#) on page 38.

---

If there is no response, this indicates that CallPilot 100/150 is not functioning. Refer to [“CallPilot 100/150 does not function at all”](#) on page 62.

If CallPilot 100/150 responds with the appropriate prompt, there is a communication problem on the serial port. Continue with the steps in this procedure until you find the problem.



- 1 Ensure the RS-232 terminal communication parameters are set to 9600 baud/ 8 data bits/1 stop bit/no parity/no flow control. For instructions about setting these parameters, refer to the manual supplied with the terminal.
- 2 Check the RS-232 cable. Ensure it is connected to the serial port on CallPilot 100/150 and to the serial port on the terminal.
- 3 Reset the terminal (or terminal emulation software).
- 4 On the RS-232 cable, use a multi-tester to check the continuity of the pins:
  - pin 2 - pin 2
  - pin 3 - pin 3
  - pin 7 - pin 7If any check fails, replace the cable.
- 5 Use a different terminal.
- 6 If there is still a problem, reboot the CallPilot 100/150 system. If there is no improvement call your support line.

## CallPilot 100/150 does not function at all



CallPilot 100/150 is not functioning when there is no response from the terminal, or the Feature Codes do not appear on the telephone display.

- 1 Check the LEDs.

If LED  1 is blinking quickly, the Bootloader has encountered an error. Check that the Feature Cartridge is installed in the bottom PCMCIA slot.

If LED  1 and LED  2 are blinking quickly, the Power-on Diagnostics have failed. Refer to [“The Power-on Diagnostics fail”](#) on page 63.
- 2 Make sure that no one is logged into the Norstar Remote Utilities application. If someone is, have the person exit from Norstar Remote Utilities and then restart CallPilot 100/150. After CallPilot 100/150 has started up, the person can start Norstar Remote Utilities again.
- 3 Check to ensure the:
  - TCM port is connected to the CallPilot 100/150
  - the Power Indicator light is lit
  - power supply cord is plugged into the AC socket
  - power supply cord is connected to the CallPilot 100/150 module
  - CallPilot 100/150 module is getting power from the AC socket
- 4 Unplug the module and open the front cover. Remove the feature cartridge and then re-insert it. Make sure the feature cartridge is fully inserted in the slot.
- 5 Close the front cover and plug in the module.

## The Power-on Diagnostics fail



When LEDs  1 and  2 blink quickly, it indicates a Power-on Diagnostics fail. For information about other LED error codes, refer to [“CallPilot 100/150 LEDs” on page 26](#).

One of the following two components could be the cause of the problem: the power supply or the CallPilot 100/150. To correct the problem:

- 1 Measure the power supply voltage. If the voltage is out of specifications, replace the power supply and retest the system.  
The power supply provides 9 VDC.
- 2 If the power supply is within specifications, replace the CallPilot 100/150, then reprogram and test the system.

## Cannot access CallPilot Manager

If you cannot access CallPilot Manager, do the following:

- 1 Wait until LED  turns on before attempting to access CallPilot Manager. If LED  does not turn on, refer to [“LED 6 does not turn on after CallPilot 100/150 has finished starting up” on page 66](#).
- 2 Make sure that the IP address, subnet mask and default gateway settings are correct.
- 3 Make sure another device is not using the CallPilot 100/150 IP address. To test this, disconnect the CallPilot 100/150 from the network and use a computer on the network to ping the CallPilot 100/150 IP address. If another device answers the ping, the CallPilot 100/150 IP address is being used by another device.

## CallPilot 100/150 fails during a start up

If the CallPilot 100/150 fails during a start up, do the following:

- 1 Remove power from the CallPilot 100/150.
- 2 Check that the Software Cartridge is properly seated in the Compact Flash Adapter.
- 3 Check that the Compact Flash Adapter is properly seated in the CallPilot 100/150.
- 4 Restore power to the CallPilot 100/150.

## All of the mailboxes disappear after a software upgrade

If the upgrade cartridge is inserted in the bottom PCMCIA slot, your current software overwrites the upgrade cartridge and all of your programming is lost. Contact your Nortel Networks Service Representative for assistance.

## CallPilot 100/150 Feature Codes are inactive

There are certain situations when you must first remove the Feature Codes that you are planning to use before you install the new CallPilot 100/150 software. These situations include:

- when you are activating new Voice Mail or Call Center functionality
- a new installation of Voice Mail or Call Center

To remove Feature Codes that may have been used by other applications, use the External Feature Inquiry utility (☎ \* \* X F T E S T) before you install the new CallPilot 100/150 software. The External Feature Inquiry utility can be used only from a two-line display telephone.

### To remove Feature Codes

1. Unplug the power to the CallPilot 100/150.

2. Press ☎ \* \* X F T E S T.

which is the same as

Press ☎ \* \* 9 3 8 3 7 8.

```

Password:
RETRY

```

3. Enter <the Installer password>

The default password is C O N F I G

(2 6 6 3 4 4). For more information about the Installer password, refer to the Norstar Installer Guide that came with your KSU.

**Access denied** appears if you cannot use external feature inquiry from your telephone.

**In use:** appears if someone else is using external feature inquiry, or an external feature is requesting an external feature access code.

```

Feat code:
FIRST      EXIT

```

4. Press First.

The first feature code appears.

```

F9XX: xxxxxxxx
TEST BACK NEXT

```

5. Press TEST.

**Note:** 9XX is the Feature Code and xxxxxxxx is a number assigned to the Feature Code.

```

F9XX: Inactive
REMOVE      OK

```

6. Press REMOVE to remove the unused code.

**Note:** If F9XX: Active appears, the code is still being used by a Norstar peripheral. Press OK.



```
F9XX: Free
TEST BACK NEXT
```

7. Press **NEXT** to show the next Feature Code.
8. Repeat steps 5 to 7 until you have tested all of the Feature Codes.

**Note:** If **None Registered** appears, all of the Feature Codes have been tested and removed. The External Feature Inquiry utility exits.

9. Press  to exit external feature inquiry.
10. Plug the power back into the CallPilot 100/150.

## CallPilot 100/150 does not reboot following \*\*STARTUP





Following a \*\*STARTUP of the KSU you must manually reboot and reset CallPilot 100/150. For information about resetting CallPilot, refer to the *CallPilot Manager Set Up and Operation Guide* or the *CallPilot 100/150 Telephone Administration Guide*.

## Inactive feature

Maintenance of the CallPilot 100/150 installation is required if you attempt to initialize the system and the display shows:

```
Inactive feature
```

Should this occur:

- 1 Check the wiring at the distribution block, then enter the System Administration Feature Code. The default code is    .

The display should show:

```
Log:
QUIT RETRY OK
```

- 2 If the display still shows **Inactive feature**, disconnect the power cord and check all the wiring for the CallPilot 100/150. Make sure the:
  - power supply is connected and plugged in
  - CallPilot 100/150 has had the necessary time to complete the four minute self testing procedure
  - CallPilot 100/150 is connected to a working station port
  - there are no telephones or peripherals connected to the station port which has the same DN that was assigned as the Control DN of a Skillset.
  - power source to the CallPilot 100/150 is not damaged
- 3 After checking all the wiring, reconnect the power. Wait four minutes and repeat step 1.

- 4 If you have checked the wiring and the module is still not operational disconnect and repackage the module, and return it to your distributor.

## Time on the CallPilot 100/150 does not match the time on the telephone system

When you change the time on the telephone system, it can take up to 10 minutes for the time on the CallPilot 100/150 to change.

## LED error messages



CallPilot 100/150 uses the LEDs to indicate an error message.

### LED 1 is blinking quickly



If LED  1 is blinking quickly, the Bootloader has encountered an error.

- 1 Make sure the feature cartridge is in the bottom PCMCIA slot and it is seated properly.
- 2 Make sure no one is logged into Norstar Remote Utilities. If someone is, ask them to log out until the CallPilot 100/150 has finished rebooting.



### LED 1 and LED 2 are blinking quickly

If LED  1 and LED  2 are blinking quickly, the Power-on Diagnostics have failed. Refer to [“The Power-on Diagnostics fail” on page 63](#).

### LEDs 1 to 4 turn on at power up but do not briefly turn off during start up

LEDs  1 to  4 turn off briefly during the start up process. If these LEDs do not turn off briefly, the hardware initialization has failed. Refer to [“The Power-on Diagnostics fail” on page 63](#).

### One or more of LEDs 1 to 4 do not turn on after CallPilot 100/150 has finished starting up

LEDs  1 to  4 indicate the lines that are connected to the telephone system. If any of these LEDs are off, the LED number indicates the line number that is not connected to the telephone system. If the lines are supposed to be connected to the telephone system:

- 1 Check the wiring between the telephone system and the CallPilot 100/150.
- 2 Make sure the wiring between the telephone system and the CallPilot 100/150 is less than 15 meters (50 feet) long.

### LED 6 does not turn on after CallPilot 100/150 has finished starting up

If LED  does not turn on a few minutes after CallPilot 100/150/ has finished starting up, the application has failed to start. Refer to [“CallPilot 100/150 does not function at all” on page 62](#).

---

## Appendix A

### Modem Access

---

When there is no access to the CallPilot 100/150 using a LAN connection or the serial port, you can use the modem to access to CallPilot 100/150.



**Note:** Although you can access CallPilot Manager using the modem, Nortel Networks recommends you use a LAN connection or an Ethernet crossover cable to access CallPilot Manager.

Modem access is intended for Nortel Networks support personnel and CallPilot 100/150 distributors.



**Caution:** The CallPilot modem uses three voice channels when connected to the support computer. Nortel Networks recommends that you do not use the modem during peak use times.

Do not connect the support computer modem to an internal (extension) line.

---

## Configuring your computer to access the CallPilot modem

To configure your computer to access the CallPilot modem, you must:

- connect a telephone to your computer modem
- create a Dial-Up Networking connection
- install the Nortel Networks Modem Configuration Utility

### Connecting a telephone to your computer modem

In order to access the CallPilot modem, you need a telephone connected to your computer modem. You use this telephone to log in to the System Administrator mailbox on the CallPilot system. From this mailbox you can access the CallPilot modem.



**Caution:** Connect only an analog telephone to your computer modem. Do not connect a Norstar digital telephone to your computer modem.

If your computer has a modem with two telephone cable connectors, connect the telephone to the jack designated for a telephone. If you are unsure which connector is for a telephone, refer to the documentation that came with your modem.

If your computer has a modem with one telephone cable connector, you need to use a telephone line splitter. To connect the line splitter:

- 1 Disconnect the telephone line for the modem from the wall outlet.
- 2 Insert the line splitter into the wall outlet.
- 3 Connect the telephone line for the modem to one of the connectors on the line splitter.
- 4 Connect the telephone line for the telephone to the other connector on the line splitter.

## Creating a Dial-Up Networking connection

You require a Dial-Up Networking connection to access the CallPilot modem. This connection must be configured for Operator assisted or manual dialing.



**Note:** If Dial-Up Networking is not installed on your computer, you must install it before you can proceed. Refer to the documentation that came with your Windows operating system for instruction on how to install Dial-Up Networking.

---

### Creating a Dial-Up Networking connection on Windows 95 or Windows 98

- 1 Click the **Start** button and then click **Programs**.
- 2 Click **Accessories** and then click **Communications**.
- 3 Click **Dial-Up Networking**.  
The Dial-Up Networking window appears.
- 4 Double click the **Make New Connection** icon.
- 5 In the **Type a name for the computer you are dialing** box, enter a name for the CallPilot connection.
- 6 From the **Select a modem** drop list, click the modem you are going to use for this connection.
- 7 Click the **Configure** button.
- 8 Click the **Options** tab.
- 9 Select the **Operator assisted or manual dialing** option and then click the **OK** button.
- 10 Click the **Next** button.
- 11 Enter the telephone number and area code of the CallPilot system.
- 12 Click the **Finish** button.

### Configuring the Dial-Up Networking TCP/IP parameters on Windows 95 or Windows 98

- 1 Right click the Dial-Up Networking connection you created for the CallPilot system and then click **Properties**.
- 2 Click the **Server Type** tab.

- 3 In the **Advanced options** box, select the **Log on to network** option:
- 4 In the **Advanced options** box, clear the following options:
  - Enable software compression**
  - Require encrypted password**
  - Require data encryption**
  - Record a log file for this connection**
- 5 In the **Allowed network protocols** box, select the **TCP/IP** option.
- 6 In the **Allowed network protocols** box, clear the following options:
  - NetBEUI**
  - IPX/SPC Compatible**
- 7 Click the **TCP/IP Settings** button.
- 8 Select the **Specify an IP address** option.
- 9 In the **IP address** box, enter the IP address of CallPilot system, but change the last set of digits to a different number.  
For example, if the CallPilot IP address is *192.168.0.1*, enter *192.168.0.10*.



**Note:** The IP address you enter here is used to identify your computer during the modem connection. It does not affect the LAN configuration of your computer.

---

- 10 Clear the following options:
  - Use IP header compression**
  - Use default gateway on remote network**
- 11 Click the **OK** button.
- 12 Click the **OK** button.

### **Creating a Dial-Up Networking connection on Windows NT 4.0**

- 1 Click the **Start** button and then click **Programs**.
- 2 Click **Accessories** and then click **Dial-Up Networking**.  
The Dial-Up Networking dialog box appears.
- 3 Click the **More** button and then click **Operator assisted or manual dialing**.
- 4 Click the **New** button.
- 5 Enter a name for the CallPilot connection.
- 6 Select the **I know all about dial up connections and would prefer to edit the properties directly** option.  
The **Edit Phonebook Entry** dialog box appears.
- 7 Refer to [“Configuring the Dial-Up Networking TCP/IP parameters on Windows NT 4.0”](#) for information about this dialog box.

### Configuring the Dial-Up Networking TCP/IP parameters on Windows NT 4.0

- 1 Click the **Configure** button.
- 2 Click the **Initial speed** drop list and then click **115200**.
- 3 Select the **Enable hardware flow control** option.
- 4 Clear the following options:  
**Enable modem error control**  
**Enable modem compression**
- 5 Click the **OK** button.
- 6 Click the **Server** tab.
- 7 Click the **Dial-Up server type** drop list, and then click the **PPP:Internet, Windows 95/98/NT4** option.
- 8 Select the following options:  
**TCP/IP**  
**Enable software compression**  
**Enable PPP LPC extensions**
- 9 Click the **TCP/IP Settings** button.
- 10 Select the **Use the following IP address** option.
- 11 Enter the IP address of CallPilot system, but change the last set of digits to a different number. For example, if the CallPilot IP address is *192.168.0.1*, enter *192.168.0.10*.



**Note:** The IP address you enter here is used to identify your computer during the modem connection. It does not affect the LAN configuration of your computer.

---

- 12 Clear the following options:  
**Use IP header compression**  
**Use default gateway on remote network**
- 13 Click the **OK** button.
- 14 Click the **Security** tab.
- 15 Select the **Accept any authentication including clear text** option.
- 16 Click the **OK** button.

If you want to access the Dial-Up Networking TCP/IP parameters to check or edit the settings, use the following procedure

- 1 Click the **Start** button and then click **Programs**.
- 2 Click **Accessories** and then click **Dial-Up Networking**.  
The Dial-Up Networking dialog box appears.
- 3 Click the **More** button and then click **Edit Entry and modem properties**.

### Creating a Dial-Up Networking connection on Windows 2000 or Windows XP

- 1 Click the **Start** button and then click **Programs**.
- 2 Click **Accessories** and then click **Communications**.
- 3 Click **Network and Dial-Up Connections**.  
The Network and Dial-Up Connections dialog box appears.
- 4 Double click the **Make new Connection** icon.  
The Network Connection Wizard appears.
- 5 Click the **Next** button.
- 6 Select the **Dial-up to private network** option.
- 7 Click the **Next** button.
- 8 In the **Phone number** box, enter a telephone number.  
It does not matter what telephone number you enter in this box because the number is not used for the connection to the CallPilot system.
- 9 Click the **Next** button.
- 10 Ensure the **For All users** option is selected.
- 11 Click the **Next** button.
- 12 Enter a name for this connection.
- 13 Click the **Finish** button.

### Configuring the Dial-Up Networking TCP/IP parameters on Windows 2000 or Windows XP

- 1 The new connection you just created should now be displayed. If it is not displayed, right click on the Dial-Up Networking connection you created for CallPilot and then click **Properties**.
- 2 Click the **Configure** button.
- 3 Clear the following options:  
**Enable hardware flow control**  
**Enable modem error control**  
**Enable modem compression**  
**Show Terminal window**
- 4 Make sure the **Enable modem speaker** option is selected so that you can hear the modem negotiation.
- 5 Click the **OK** button.
- 6 Click the **Security** tab.
- 7 Select the **Advanced (custom settings)** option.
- 8 Click the **Settings** button.
- 9 Ensure that Data encryption is set to **Optional encryption (connect even if no encryption)**.
- 10 Select the **Allow these protocols** option.

- 11 Select the **Unencrypted password (PAP)** option and clear the other options.
- 12 Click the **OK** button.  
A warning message appears.
- 13 Click the **Yes** button.
- 14 Click the **Networking** tab.
- 15 In the **Type of dial-up server I am calling** drop list, click **PPP:Windows 95/98/NT4/2000, Internet**.
- 16 Click the **Settings** button.
- 17 Ensure the following options are selected:
  - Enable LCP extensions**
  - Enable software compression**
  - Negotiate multi-link for single link connections**
- 18 Click the **OK** button.
- 19 Select the **Internet Protocol (TCP/IP)** option.
- 20 Click the **Internet Protocol (TCP/IP)** heading and then click the **Properties** button.
- 21 Select the **Use the following IP address** option.
- 22 Enter an IP address that is on the same network segment as the CallPilot system.  
For example, if the CallPilot IP address is *192.168.0.1*, enter *192.168.0.2*.



**Note:** The IP address you enter here is used to identify your computer during the modem connection. It does not affect the LAN configuration of your computer.

---

- 23 Click the **OK** button to close the Internet Protocol (TCP/IP) properties.
- 24 Click the **OK** button to close the Dialup properties.

## Installing the Nortel Networks Modem Configuration Utility

Your modem requires a special configuration to access the CallPilot modem. The Modem Configuration Utility allows you to easily switch between the configuration for the CallPilot modem and the configuration for normal modem use. Each time that you run this application you will need to reboot your PC for the changes to take effect.

To install the Nortel Networks Modem Configuration Utility:

- 1 Load the CallPilot CD in the CD-ROM drive of your computer.
- 2 Open the CD folder and open the **Optional Software** folder.
- 3 Open the **Modem Configuration Utility** folder.
- 4 Copy the file **CPsecureModem.exe** to a folder on your computer.
- 5 Remove the CallPilot CD from your computer.



## Enabling the CallPilot modem

You must enable the CallPilot modem before you access the system using the modem.

### Enabling Modem access using CallPilot Manager

- 1 Log on to CallPilot Manager.
- 2 Click the **Configuration** heading.
- 3 Click the **Access Passwords** link.
- 4 Enter a password in the **Modem Access** box.
- 5 Enter the password again in the **Confirmation** box.
- 6 Click the **Submit** button.



**Note:** To disable Modem access, clear the **Modem Access** and **Confirmation** boxes and then click the **Submit** button.

### Enabling Modem access using a telephone

Follow this procedure to enable the Modem access password using a telephone.

1. Press **[\*] 9 8 3**.
2. Enter the system administration mailbox number and password.
3. Press **[4]**.
4. Press **NEXT**.
5. Press **NEXT**.
6. Press **OK**.
7. Press **CHNG**.
8. Enter the new Modem access password and press **OK**.  
**Note:** If you do not enter a password, Modem access is disabled.
9. Re-enter the new Modem access password and press **OK**.
10. Press **[hook]**.

```
Log:
QUIT  RETRY  OK
```

```
Admin
MBOX  AA  OTHR
```

```
Voice Mail:Y
CHNG          NEXT
```

```
Dir avail:Y
CHNG          NEXT
```

```
Match:Lastname
CHNG          OK
```

```
Modem access:N
CHNG          OK
```

```
Pswd:
RETRY        OK
```

```
Again:
RETRY        OK
```

## Changing the modem access password using a telephone

Follow this procedure to change the Modem access password using a telephone.

- |                           |  |
|---------------------------|--|
| Log:<br>QUIT RETRY OK     | 1. Press <b>[*] 9 8 3</b> .                                      |
| Admin<br>MBOX AA OTHR     | 2. Enter the system administration mailbox number and password.  |
| Voice Mail:Y<br>CHNG NEXT | 3. Press <b>[4]</b> .  |
| Dir avail:Y<br>CHNG NEXT  | 4. Press <b>NEXT</b> .   |
| Match:Lastname<br>CHNG OK | 5. Press <b>NEXT</b> .   |
| Modem access:Y<br>CHNG OK | 6. Press <b>OK</b> .   |
| Modem access:N<br>CHNG OK | 7. Press <b>CHNG</b> .   |
| Pswd:<br>RETRY OK         | 8. Press <b>CHNG</b> .   |
| Again:<br>RETRY OK        | 9. Enter the new Modem access password and press <b>OK</b> .     |
|                           | 10. Re-enter the new Modem access password and press <b>OK</b> . |
|                           | 11. Press <b>[END]</b> .   |

## Disabling the Modem access password using a telephone

Follow this procedure to disable the Modem access password using a telephone.

- |                           |   |
|---------------------------|---|
| Log:<br>QUIT RETRY OK     | 1. Press <b>[*] 9 8 3</b> .                                     |
| Admin<br>MBOX AA OTHR     | 2. Enter the system administration mailbox number and password. |
| Voice Mail:Y<br>CHNG NEXT | 3. Press <b>[4]</b> .   |
| Dir avail:Y<br>CHNG NEXT  | 4. Press <b>NEXT</b> .  |
| Match:Lastname<br>CHNG OK | 5. Press <b>NEXT</b> .  |
| Modem access:Y<br>CHNG OK | 6. Press <b>OK</b> .  |
| Modem access:N<br>CHNG OK | 7. Press <b>CHNG</b> .  |
|                           | 8. Press <b>[END]</b> .   |

## Connecting to the CallPilot system

To connect to the CallPilot system you must:

- configure your modem to access the CallPilot modem
- connect to the CallPilot modem

## Configuring your modem to access the CallPilot modem

The CallPilot modem requires a special configuration for access. This requirement helps prevent unauthorized access to the CallPilot system.

To configure your modem:

- 1 Open the folder that contains the Nortel Networks Modem Configuration Utility. (CPsecureModem.exe).
- 2 Double click **CPsecureModem.exe**.  
The Modem Configuration Utility opens. The current setting of the Modem appears at the bottom of the dialog window.
- 3 Select the **Configure Modem for Secure Access** option.
- 4 Click the **OK** button.
- 5 In you are using Windows NT 4.0, Windows 2000 or Windows XP, restart your computer.

After your computer finishes restarting, the modem is ready to connect to the CallPilot modem.



**Note:** You need to set the modem back to normal mode if you want to connect to a system other than the CallPilot. For information about how to set the modem back to normal mode, refer to [“Configuring your modem for normal modem connections” on page 77.](#)

---

## Connecting to the CallPilot modem

To connect to the CallPilot system:

- 1 Use the **Start** menu to open the Dial-Up Networking window.
- 2 From the **Advanced** menu, select **Operator-Assisted Dialing**.  
If a check mark appears beside Operator-Assisted Dialing, this option is already selected.
- 3 Double click the Dial-Up Networking connection you created for the CallPilot system.
- 4 Set the User Name to **CallPilot**.
- 5 Set the Password to **administrator**.
- 6 If there is a Domain box, set the Domain to the IP address you entered for the Dial-Up Networking TCP/IP parameters of this connection. For example, enter 192.168.0.2.

- 7 Click the **Dial** button.  
The Operator-Assisted or Manual Dial dialog box appears.
- 8 Use the telephone connected to your computer modem to dial the CallPilot system you want to access. You must be answered by the CallPilot voicemail.
- 9 When voicemail answers, log into the administrators mailbox using the Modem Access password. To do this, press **\*** **\***, the System Administrator mailbox number, the Modem Access password and then **#**.  
For example, **\*** **\*** **1** **0** **0** **2** **1** **1** **1** **1** **#**.



**Note:** If you are in Europe or Australia, press **8** **8**, the System Administrator mailbox number the Modem Access password and then **#**.  
For example, **8** **8** **1** **0** **0** **2** **1** **1** **1** **1** **#**.

---

- 10 If there are enough CallPilot resources to make a modem connection, the system starts counting down from 5.
- 11 When the system reaches 1, click the **Connect** button and hang up the telephone. A message appears when the connection is established.



#### Tip

If the prompt **One moment please** plays, the system currently does not have sufficient resources to access the modem. Wait until the count down reaches 1 before you click the Connect button.

If the prompt **One moment please** plays several times and then the prompt **Exiting the system, goodbye** plays, try calling again.

---

Your computer is now connected to the CallPilot system and you can access the web interface.

### *Accessing the CallPilot system using the CallPilot console*

- 1 Click the **Start** button and then click **Run**.
- 2 Enter **Telnet 192.168.0.2** and click **OK**.



**Note:** The IP address above is an example only. The IP address you enter is the IP address of the CallPilot system plus one.

In the example above, the IP address shown is the default CallPilot IP address (192.168.0.1) plus one (192.168.0.2).

---

- 3 Log on to the CallPilot console.

When you are finished with the CallPilot system, end your connection to the CallPilot modem.



**Note:** After you are finished accessing the CallPilot system, you must reconfigure your modem if you want to use it for normal modem connections.

---

### *Accessing the CallPilot system using CallPilot Manager*

- 1 Start your web browser.
- 2 In the URL field, enter **http://<CallPilot IP Address>**.
- 3 Log on to CallPilot Manager

When you are finished with the CallPilot system, end your connection to the CallPilot modem.



**Note:** After you are finished accessing the CallPilot system, you must reconfigure your modem if you want to use it for normal modem connections. This requires a reboot of your PC.

---

### **Configuring your modem for normal modem connections**

To configure your modem for normal connections:

- 1 Open the folder that contains the Nortel Networks Modem Configuration Utility (CPsecureModem.exe).
- 2 Double click **CPsecureModem.exe**.  
The Modem Configuration Utility opens.
- 3 Select the **Configure Modem for Normal Operation** option.
- 4 Click the **OK** button.
- 5 If you are using Windows NT 4.0, Windows 2000 or Windows XP, restart your computer.

After your computer finishes restarting, the modem is ready for normal modem connections.



---

## Appendix B

### Norstar Directory Numbers

---

Norstar is a digital system, capable of carrying two simultaneous voice conversations over a single station port. These two voice channels are referred to as the B1 and B2 channels. There are times when you will want to monitor each of the B1 and B2 channels that CallPilot 100/150 uses. You can do this by programming a Norstar telephone with Autodial keys for the B1 and B2 extension numbers.

The following charts can be used to determine the default B1 and B2 Directory Numbers (DN) of the Norstar Compact and Modular systems.

**Table 11** Non-expanded Modular ICS DNs

Station ports	B1 DNs	B2 DNs	Module number
101 - 132	21 - 52	53 - 84	KSU #1
201 - 248	001 - 048		KSU #2

**Table 12** Modular ICS 2-port cartridge DNs

Station ports	B1 DNs	B2 DNs	Module number
101 - 132	221 - 252	285 - 316	KSU #1
301 - 316	253 - 268	317 - 332	TM #3
401 - 416	269 - 284	333 - 348	TM #4
201 - 248	001 - 048		KSU #2
401 - 412	049 - 060		TM #4
301 - 312	061 - 072		TM #3

**Table 13** Modular ICS 6-port cartridge DNs

<b>Station ports</b>	<b>B1 DNs</b>	<b>B2 DNs</b>	<b>Module number</b>
101 - 132	221 - 252	349 - 380	KSU #1
301 - 316	253 - 268	381 - 396	TM #3
401 - 416	269 - 284	397 - 412	TM #4
501 - 516	285 - 300	413 - 428	TM #5
601 - 616	301 - 316	429 - 444	TM #6
701 - 716	317 - 332	445 - 460	TM #7
801 - 816	333 - 348	461 - 476	TM #8
201 - 248	001 - 048		KSU #2
801 - 812	049 - 060		TM #8
701 - 712	061 - 072		TM #7
601 - 648	073 - 084		TM #6
501 - 512	085 - 096		TM #5
401 - 412	097 - 108		TM #4
301 - 312	109 - 120		TM #3

## **Programming CallPilot 100/150 DNs to memory buttons**

As a troubleshooting aid, it is helpful to program the CallPilot 100/150 DNs to appear on the memory buttons of a Norstar telephone.

After you have determined the CallPilot 100/150 DNs, program them onto memory buttons with indicators.

When the CallPilot 100/150 DNs are programmed to memory buttons, it is easy to monitor CallPilot 100/150 traffic levels, and determine if any CallPilot 100/150 ports are not functioning.



---

# Glossary

---

**Administration**

The tasks involved in maintaining Mailboxes, Greetings, Skillsets, Agents and System configuration.

**Agent**

An agent is a person who is assigned to answer calls for one or more Skillsets in a Call Center.

**Alarms**

Messages sent by CallPilot indicating that something requires the system administrator's attention.

**Alternate language**

The second language CallPilot can be programmed to operate in.

**Baud rate**

A unit of measurement of data processing speed. It is approximately equivalent to Bits Per Second (BPS). Typical baud rates are 300, 1200, 2400, 4800, and 9600.

**Bit**

An abbreviation for binary digit. A bit is the smallest unit of information recognized by the computer. A bit has one of two values (0 or 1) to indicate off or on.

**Byte**

The amount of space required to store a single character. One byte equals eight bits.

**Call Center**

The Call Center Software receives, holds and routes calls to agents in a call center.

**CCR (Custom Call Routing)**

Call Paths that let callers select options to direct their calls along paths you create.

**Central office line**

The telephone lines that connect the Norstar KSU to the Public Switched Telephone Network (PSTN).

**CLID**

Caller Line Identification.

**Company Directory**

An internal list containing the names of users with initialized mailboxes designated to appear in the directory.

**Configuration**

The tasks involved in setting up the different parameters of CallPilot . For example, configuring the telephone lines answered by CallPilot . See also **Administration**.

**Cursor**

A marker on the monitor screen that indicates where the next input from the keyboard or mouse will appear.

**Default**

The parameters that are preset within CallPilot .

**Disconnect supervision**

A feature on central office lines that notifies the Norstar KSU when the party on the other end of the line hangs up.

**Display**

A one or two-line screen on a Nortel Networks telephone that shows CallPilot commands and options.

**Display buttons**

The three buttons that appear on a Norstar two-line display. When pressed, these buttons select the specified CallPilot option.

**Display Options**

The choices available to a user that appear on the Norstar two-line display. Options appearing on the display can be selected using the display or dialpad buttons.

**DN**

Directory Number.

**DTMF**

Dual Tone Multi Frequency. The sounds the telephone keys make to identify themselves.

**Ethernet**

A widely used Local Area Network (LAN) protocol that uses coaxial cable or twisted pair wiring for connecting computers.

**Feature cartridge**

A device inserted into the CallPilot 100/150 that contains the initial software load or an upgrade.

**Feature Code**

A unique three-digit code that is used to access CallPilot features and options from a telephone.

**Flash Memory**

Memory that stores data even when CallPilot 100/150 is restarted or disconnected from the power supply. Flash memory contains instructions that CallPilot 100/150 needs to operate. The instructions stored in flash memory cannot be changed and are used by the CallPilot 100/150 each time it is turned on or restarted.

**General Delivery Mailbox**

One of the two Special Mailboxes. This mailbox collects messages for individuals in a company who have not been assigned a Personal Mailbox.

**Group list**

A collection of mailbox numbers that are assigned a special "Group" number by CallPilot . When a message is sent to a Group List, all the mailboxes in the list receive the message.

**Hardware**

The physical components of a CallPilot 100/150.

**Hz (hertz)**

A unit of measure for indicating frequency in cycles per second.

**Initialization**

The steps required to prepare hardware or software for operation.

**Install**

To set up for operation. Hardware is installed by attaching it to the appropriate connectors or sockets.

**Keycode**

A keycode is a code that allows you to add features to a CallPilot 100/150. For example, the Mailbox Keycode allows you to add more mailboxes to the CallPilot 100/150.

A keycode consists of 3 eight digit numbers. It is also know as a software authorization code.

**KSU**

Key Service Unit, a Norstar business telephone system.

**Local Area Network (LAN)**

A group of computers physically connected in a manner that lets them communicate and interact with each other.

**Mailbox**

A storage place for messages on CallPilot .

**Mbyte**

The abbreviation for megabyte. A megabyte is equal to 1,048,576 bytes. Megabyte is also abbreviated as MB.

**Modem**

A communications device that allows data to be exchanged between computers over telephone lines. The exchange is done by electronic processes called modulation and demodulation. The modem changes (modulates) the data into tones to send to another modem and also converts (demodulates) tones when receiving from another modem.

**Norstar**

A telephone system to which the CallPilot 100/150 connects.

**Option**

A CallPilot choice that is given to a user through voice or display prompts.

**PCMCIA**

Personal Computer Memory Card International Association.  
A PCMCIA card stores the CallPilot software.

**Password**

A four to eight digit number that is entered using the dialpad. A password is used to open mailboxes or perform configuration tasks.

**Port**

A connector on the CallPilot 100/150 that allows data exchange with other devices, such as an RS-232 terminal.

A port is also a connection to the Norstar KSU. See *TCM port*.

**Power cable**

A cable that connects the CallPilot 100/150 to a power source.

**RAM (Random Access Memory)**

Computer memory that stores data temporarily. RAM stores the data used by the microprocessor as it executes instructions. The contents of RAM are erased each time the CallPilot 100/150 is turned off or restarted.

**RS-232 terminal**

A device with a display, such as a computer or a laptop, that you can connect to the serial port of the CallPilot 100/150.

**Serial cable**

A cable that transfers data one bit at a time. This cable connects the CallPilot 100/150 to an RS232 terminal.

**Serial port**

A port that sends and receives data one bit at a time. This port is used to connect the CallPilot 100/150 to an RS-232 terminal.

**System administrator**

The person who is responsible for setting up and configuring CallPilot .

**TCM port**

Time Compression Multiplexing port. This is the type of port that you use to connect the CallPilot 100/150 to the Norstar KSU.

**Tone dial telephone**

A push button telephone that emits DTMF tones.

**Transmission Control Protocol/Internet Protocol (TCP/IP)**

A language governing communication among all computers on the Internet.

**Voice channel**

A communication path that CallPilot uses to send voice messages to and from the Norstar KSU. There are two voice channels on each TCM port.

**Voice prompts**

The prerecorded voice instructions that play when accessing the different CallPilot features and options. Voice prompts also enable a caller to proceed along the call path of a CCR Tree.

**Wide Area Network (WAN)**

A collection of computers connected or networked to each other over long distances, typically using common carrier facilities.



---

# Index

---

**A**

Active agents, maximum 17  
 Attendant DN 36  
 Auto-Attendant 17

**B**

B1 and B2 directory numbers 79  
 Back up, CallPilot information 51  
 Backup and Restore Utility, installing 51  
 Base Application 36  
 Basic call center 17  
 Browser, requirements 29, 30

**C**

Call Center  
   resetting the administrator password 48  
   troubleshooting 64  
 Call Center Reporting 17  
 Call Interrupt 17  
 Call recording 17  
 CallPilot  
   attendant 36  
   back up 51  
   connecting to 31  
   features list 17  
   initializing 29  
   log files, retrieving 55  
   logging on 35  
   restore 53  
 CallPilot Backup and Restore Utility 51  
 CallPilot Manager  
   about 29  
   requirements 30  
 Caution symbol 16  
 Communications parameters, required 32  
 Compatible telephone systems  
   Norstar 18  
 Computer requirements 30  
 Conventions 16  
   Cautions 16  
   Notes 16  
   text 11  
 Country 36

Custom Call Routing 17

**D**

Default Gateway 36  
 Determining Feature Codes 38  
 DNS server 22, 35

**E**

Electrical checklist 21  
 EMC requirements 31  
 Environmental checklist 21  
 Ethernet crossover cable 34  
   pinout 34  
 Ethernet port, location 19  
 External Feature inquiry 64

**F**

Feature Codes 38  
   determining 38  
   inactive 64  
   removing 64  
 Features of CallPilot 17  
 From Extension 37  
 From Line 36

**H**

Hardware installation procedure 23  
 Help, how to get 11  
 Humidity requirements 21

**I**

Inactive, Feature Codes 64  
 Initializing CallPilot 29  
 Instructions, presentation 16  
 IP Address 35  
 IP address  
   changing 31, 32, 34  
   default 22, 31  
   requirements 22

**K**

KSU, compatible Norstar 18

**L**

LAN, requirement for 22  
Language Configuration Utility 43  
Languages, changing 43  
LEDs 26  
    error messages 66  
Log files 55

**M**

Mailbox Keycode 37  
Mailbox, resetting password 47  
Memory buttons 79  
    Programming 79  
Message storage, upgrading 58  
Modem Access 67  
Modem, resetting access password 48

**N**

Next-hop router 36  
Norstar directory numbers 79  
Norstar Remote Utilities 62  
Norstar telephone systems 18  
Note symbol 16  
Number of rings 36

**O**

Opening the CallPilot 24  
Operator, resetting password 46  
Outdial Method 37

**P**

Package check list 21  
Passwords  
    resetting 45  
    resetting administrator's 45  
    resetting mailbox 47  
    resetting modem access 48  
    resetting operator's 46  
    resetting the Call Center administrator 48  
PCMCIA slots 19  
Pinouts  
    Ethernet crossover cable 34  
    serial port 31  
    TCM ports 24

Port A pinout 24  
Port B pinout 24  
Ports  
    connecting to 24  
    location 19  
    TCM pinouts 24  
Power connector, location 19  
Power requirements 20  
Power-on diagnostics failure 63  
Primary DNS 35  
Primary Language 36  
Primary UI Style 36  
Publications, related 12

**Q**

Quick Install Wizard, running 35

**R**

Requirements  
    CallPilot Manager 30  
    communications parameters 32  
    computer 30  
    terminal 31  
Restore, CallPilot information 53  
Router, next-hop 36  
RS-232 terminal 61  
    Cannot communicate 61

**S**

Secondary DNS 35  
Serial cable 31  
Serial port  
    location 19  
    pinout 31  
Skillsets, maximum 17  
Software  
    upgrading 57  
Storage (hours) 17  
Subnet Mask 35  
Switches  
    Norstar 18  
Symbols 16  
System administrator password, resetting 45  
System parts, listed 18



**T**

## TCM ports

location 19

pinouts 24

## Temperature requirements 21

## Terminal

requirements 31

using to change IP address 32

## Text conventions 11

## To Extension 37

## To Line 36

## Troubleshooting 64

CallPilot does not reboot 65

Feature Codes 64

LEDs 66

power-on diagnostics fail 63

RS-232 61

Terminal 61

**U**

## UI style 36

## Upgrading

message storage 58

software 57

## User interface style 36

**W**

## Wall mount bracket 23

## Wall mounting CallPilot 23

## Warning symbol 16

## Web browser, requirements 29, 30

**X**

## XF Test 64

